

3GPP2 C.S0065-A

Version 1.0

Date: August 17, 2009



**3RD GENERATION
PARTNERSHIP
PROJECT 2
"3GPP2"**

cdma2000 Application on UICC for Spread Spectrum Systems

2009 COPYRIGHT

3GPP2 and its Organizational Partners claim copyright in this document and individual Organizational Partners may copyright and issue documents or standards publications in individual Organizational Partner's name based on this document. Requests for reproduction of this document should be directed to the 3GPP2 Secretariat at secretariat@3gpp2.org. Requests to reproduce individual Organizational Partner's documents should be directed to that Organizational Partner. See www.3gpp2.org for more information.

Revision History

1

2

<u>Revision</u>	<u>Description</u>	<u>Date</u>
C.S0065-0 v1.0	Initial Release	June 2006
C.S0065-0 v2.0	Initial Release, Version 4	July 2008
C.S0065-A v1.0	Revision A	August 2009

3

Contents

1		
2	1. INTRODUCTION	1
3	2. SCOPE.....	2
4	3. REFERENCES	3
5	4. DEFINITIONS, SYMBOLS, ABBREVIATIONS AND CODING CONVENTIONS	7
6	5. FILES	8
7	5.1 CONTENTS OF FILES AT THE MF LEVEL.....	8
8	5.2 CONTENTS OF FILES AT THE CSIM ADF (APPLICATION DF) LEVEL	9
9	5.2.1 <i>EF_{COUNT}</i> (Call Count).....	9
10	5.2.2 <i>EF_{IMSI_M}</i> (IMSI_M).....	10
11	5.2.3 <i>EF_{IMSI_T}</i> (IMSI_T).....	13
12	5.2.4 <i>EF_{TMSI}</i> (TMSI).....	14
13	5.2.5 <i>EF_{AH}</i> (Analog Home SID).....	16
14	5.2.6 <i>EF_{AOP}</i> (Analog Operational Parameters).....	17
15	5.2.7 <i>EF_{ALOC}</i> (Analog Location and Registration Indicators).....	18
16	5.2.8 <i>EF_{CDMAHOME}</i> (CDMA Home SID, NID).....	20
17	5.2.9 <i>EF_{ZNREGI}</i> (CDMA Zone-Based Registration Indicators).....	22
18	5.2.10 <i>EF_{SNREGI}</i> (CDMA System-Network Registration Indicators).....	24
19	5.2.11 <i>EF_{DISTREGI}</i> (CDMA Distance-Based Registration Indicators).....	26
20	5.2.12 <i>EF_{ACCOLC}</i> (Access Overload Class ACCOLCp).....	28
21	5.2.13 <i>EF_{TERM}</i> (Call Termination Mode Preferences)	29
22	5.2.14 <i>EF_{SSCI}</i> (Suggested Slot Cycle Index).....	30
23	5.2.15 <i>EF_{ACP}</i> (Analog Channel Preferences)	31
24	5.2.16 <i>EF_{PRL}</i> (Preferred Roaming List)	32
25	5.2.17 <i>EF_{RUIMID}</i> (UIM_ID).....	33
26	5.2.18 <i>EF_{CST}</i> (CSIM Service Table).....	34
27	5.2.19 <i>EF_{SPC}</i> (Service Programming Code).....	38
28	5.2.20 <i>EF_{OTAPASPC}</i> (OTAPA/SPC_Enabled)	40
29	5.2.21 <i>EF_{NAMLOCK}</i> (NAM_LOCK)	41
30	5.2.22 <i>EF_{OTA}</i> (OTASP/OTAPA Features)	42
31	5.2.23 <i>EF_{SP}</i> (Service Preferences).....	43
32	5.2.24 <i>EF_{ESNME}</i> (ESN_ME).....	44
33	5.2.25 <i>Reserved</i>	45
34	5.2.26 <i>EF_{LI}</i> (Language Indication).....	46
35	5.2.27 <i>EF_{FDN}</i> (Fixed Dialling Numbers)	47
36	5.2.28 <i>EF_{SMS}</i> (Short Messages).....	48
37	5.2.29 <i>EF_{SMSP}</i> (Short Message Service Parameters).....	50
38	5.2.30 <i>EF_{SMSS}</i> (SMS Status).....	53
39	5.2.31 <i>EF_{SSFC}</i> (Supplementary Services Feature Code Table)	55
40	5.2.32 <i>EF_{SPN}</i> (CDMA Home Service Provider Name)	59
41	5.2.33 <i>EF_{USGIND}</i> (UIM_ID/SF_EUIMID Usage Indicator).....	61
42	5.2.34 <i>EF_{AD}</i> (Administrative Data)	62

1	5.2.35	<i>EF_{MDN} (Mobile Directory Number)</i>	64
2	5.2.36	<i>EF_{MAXPRL} (Maximum PRL)</i>	66
3	5.2.37	<i>EF_{SPCS} (SPC Status)</i>	67
4	5.2.38	<i>EF_{ECC} (Emergency Call Codes)</i>	68
5	5.2.39	<i>EF_{ME3GPDOPC} (ME 3GPD Operation Capability)</i>	70
6	5.2.40	<i>EF_{3GPDOPM} (3GPD Operation Mode)</i>	71
7	5.2.41	<i>EF_{SIPCAP} (SimpleIP Capability Parameters)</i>	72
8	5.2.42	<i>EF_{MIPCAP} (MobileIP Capability Parameters)</i>	73
9	5.2.43	<i>EF_{SIPUPP} (SimpleIP User Profile Parameters)</i>	74
10	5.2.44	<i>EF_{MIPUPP} (MobileIP User Profile Parameters)</i>	75
11	5.2.45	<i>EF_{SIPSP} (SimpleIP Status Parameters)</i>	76
12	5.2.46	<i>EF_{MIPSP} (MobileIP Status Parameters)</i>	77
13	5.2.47	<i>EF_{SIPPAPSS} (SimpleIP PAP SS Parameters)</i>	78
14	5.2.48	<i>Reserved</i>	79
15	5.2.49	<i>Reserved</i>	80
16	5.2.50	<i>EF_{PUZL} (Preferred User Zone List)</i>	81
17	5.2.51	<i>EF_{MAXPUZL} (Maximum PUZL)</i>	82
18	5.2.52	<i>EF_{MECRP} (ME-specific Configuration Request Parameters)</i>	83
19	5.2.53	<i>EF_{HRPDACAP} (HRPD Access Authentication Capability Parameters)</i>	84
20	5.2.54	<i>EF_{HRPDUPP} (HRPD Access Authentication User Profile Parameters)</i>	85
21	5.2.55	<i>EF_{CSSPR} (CUR_SSPR_P_REV)</i>	86
22	5.2.56	<i>EF_{ATC} (Access Terminal Class)</i>	87
23	5.2.57	<i>EF_{EPRL} (Extended Preferred Roaming List)</i>	88
24	5.2.58	<i>EF_{BCSMScfg} (Broadcast Short Message Configuration)</i>	89
25	5.2.59	<i>EF_{BCSMSpref} (Broadcast Short Message Preference)</i>	90
26	5.2.60	<i>EF_{BCSMStable} (Broadcast Short Message Table)</i>	91
27	5.2.61	<i>EF_{BCSMSP} (Broadcast Short Message Parameter)</i>	93
28	5.2.62	<i>EF_{BAKPARA} (Currently used BAK Parameters)</i>	94
29	5.2.63	<i>EF_{UpBAKPARA} (Updated BAK Parameters)</i>	96
30	5.2.64	<i>EF_{MMSN} (MMS Notification)</i>	98
31	5.2.65	<i>EF_{EXT8} (Extension 8)</i>	101
32	5.2.66	<i>EF_{MMSICP} (MMS Issuer Connectivity Parameters)</i>	102
33	5.2.67	<i>EF_{MMSUP} (MMS User Preferences)</i>	106
34	5.2.68	<i>EF_{MMSUCP} (MMS User Connectivity Parameters)</i>	108
35	5.2.69	<i>EF_{AuthCapability} (Authentication Capability)</i>	109
36	5.2.70	<i>EF_{3GCIK} (3G Cipher and Integrity Keys)</i>	111
37	5.2.71	<i>EF_{DCK} (De-Personalization Control Keys)</i>	112
38	5.2.72	<i>EF_{GID1} (Group Identifier Level 1)</i>	113
39	5.2.73	<i>EF_{GID2} (Group Identifier Level 2)</i>	114
40	5.2.74	<i>EF_{CDMACNL} (CDMA Co-operative Network List)</i>	115
41	5.2.75	<i>EF_{HOME_TAG} (Home System Tag)</i>	117
42	5.2.76	<i>EF_{GROUP_TAG} (Group Tag List)</i>	118
43	5.2.77	<i>EF_{SPECIFIC_TAG} (Specific Tag List)</i>	119
44	5.2.78	<i>EF_{CALL_PROMPT} (Call Prompt List)</i>	120
45	5.2.79	<i>EF_{SF_EUIMID} (Short Form EUIMID)</i>	121
46	5.2.80	<i>EF_{EST} (Enabled Service Table)</i>	122

1	5.2.81	<i>EF_{HiddenKey}</i> (Key for hidden phone book entries)	124
2	5.2.82	<i>EF_{LCSVER}</i> (LCS Protocol Version)	125
3	5.2.83	<i>EF_{LCSCP}</i> (LCS Connectivity Parameter).....	126
4	5.2.84	<i>EF_{SDN}</i> (Service Dialling Numbers)	127
5	5.2.85	<i>EF_{EXT2}</i> (Extension2)	128
6	5.2.86	<i>EF_{EXT3}</i> (Extension3)	129
7	5.2.87	<i>EF_{ICI}</i> (Incoming Call Information)	130
8	5.2.88	<i>EF_{OCI}</i> (Outgoing Call Information)	136
9	5.2.89	<i>EF_{EXT5}</i> (Extension 5)	138
10	5.2.90	<i>EF_{CCP2}</i> (Capability Configuration Parameters 2)	139
11	5.2.91	<i>EF_{ICCID}</i> (ICC Identification)	140
12	5.2.92	<i>EF_{AppLabels}</i> (Application Labels).....	141
13	5.2.93	<i>EF_{Model}</i> (Device Model Information)	143
14	5.2.94	<i>EF_{RC}</i> (Root Certificates)	144
15	5.2.95	<i>EF_{SMSCAP}</i> (SMS Capabilities).....	147
16	5.2.96	<i>EF_{MIPFlags}</i> (MobileIP Flags).....	148
17	5.2.97	<i>EF_{SIPUPPExt}</i> (SimpleIP User Profile Parameters Extension)	149
18	5.2.98	<i>EF_{MIPUPPExt}</i> (MobileIP User Profile Parameters Extension).....	152
19	5.2.99	<i>EF_{IPV6CAP}</i> (IPv6 Capabilities).....	153
20	5.2.100	<i>EF_{TCPConfig}</i> (TCP Configurations).....	157
21	5.2.101	<i>EF_{DGC}</i> (Data Generic Configurations)	158
22	5.2.102	<i>EF_{WAPBrowserCP}</i> (WAP Browser Connectivity Parameters)	159
23	5.2.103	<i>EF_{WAPBrowserBM}</i> (WAP Browser Bookmarks).....	161
24	5.2.104	<i>EF_{MMSConfig}</i> (MMS Configuration)	163
25	5.2.105	<i>EF_{JDL}</i> (Java Download URL).....	165
26	5.3	CONTENTS OF DFS AT THE CSIM ADF (APPLICATION DF) LEVEL.....	166
27	5.3.1	Contents of files at the <i>DF_{PHONEBOOK}</i> level	166
28	5.4	CONTENTS OF EFS AT THE <i>DF_{TELECOM}</i> LEVEL.....	167
29	5.4.1	<i>EF_{ADN}</i> (Abbreviated dialling numbers).....	167
30	5.4.2	<i>EF_{EXT1}</i> (Extension 1)	167
31	5.4.3	<i>EF_{ECCP}</i> (Extended Capability Configuration Parameter)	167
32	5.4.4	<i>EF_{SUME}</i> (Set Up Menu Elements).....	167
33	5.4.5	<i>EF_{ARR}</i> (Access Rule Reference)	167
34	5.5	CONTENTS OF DFS AT THE <i>DF_{TELECOM}</i> LEVEL	169
35	5.5.1	Contents of files at the <i>DF_{GRAPHICS}</i> level.....	169
36	5.5.2	Contents of files at the <i>DF_{PHONEBOOK}</i> under the <i>DF_{TELECOM}</i>	169
37	5.5.3	Contents of files at the <i>DF_{MULTIMEDIA}</i> level	169
38	6.	INTERWORKING OF R-UIM & CSIM APPLICATION ON A UICC	170
39	6.1	FILE MAPPING	170
40	6.2	RESERVED	170
41	6.3	ACCESS CONDITIONS	170
42	6.4	RESERVED	170
43	7.	APPLICATION PROTOCOL	171
44	7.1	CSIM MANAGEMENT PROCEDURES.....	171
45	7.1.1	Initialization	171

1	7.1.2	Session Termination	172
2	7.1.3	CSIM Application Closure	172
3	7.1.4	Emergency call codes	173
4	7.1.5	Language indication	173
5	7.1.6	Administrative information request	173
6	7.1.7	CSIM Service Table request.....	173
7	7.2	CSIM SECURITY RELATED PROCEDURES.....	173
8	7.3	SUBSCRIPTION RELATED PROCEDURES	173
9	7.3.1	Phone book procedure.....	173
10	7.3.2	Dialing numbers.....	173
11	7.3.3	Short Message	176
12	7.3.4	Capability configuration parameters.....	176
13	7.3.5	Group Identifier level 1	177
14	7.3.6	Group Identifier level 2	177
15	7.3.7	Service provider name	177
16	7.3.8	Depersonalisation Control Keys	177
17	7.3.9	Co-operative Network List	177
18	7.3.10	Enabled Services Table Request	177
19	7.3.11	MMS Notifications	177
20	7.3.12	MMS Issuer Connectivity Parameters	178
21	7.3.13	MMS User Preferences.....	179
22	7.3.14	MMS User Connectivity Parameters	179
23	7.3.15	Multimedia Message Storage.....	179
24	7.4	CCAT RELATED PROCEDURES	180
25	7.4.1	Data Download via SMS-PP.....	180
26	7.4.2	Data Download via SMS Broadcast	180
27	7.4.3	Call Control by CSIM.....	180
28	7.4.4	Image Request	180
29	8.	STRUCTURE OF COMMANDS AND RESPONSES	181
30	8.1	COMMAND APDU STRUCTURE	181
31	8.1.1	Coding of Class byte	181
32	8.1.2	Coding of Instruction byte	181
33	8.1.3	Coding of Parameter bytes.....	182
34	8.1.4	Coding of Lc bytes	182
35	8.1.5	Coding of Data part.....	182
36	8.1.6	Coding of Le bytes	183
37	8.2	RESPONSE APDU STRUCTURE.....	183
38	9.	COMMANDS.....	184
39	9.1	GENERIC COMMANDS	184
40	9.2	CAT COMMANDS	184
41	9.3	DATA ORIENTED COMMANDS	184
42	9.4	CSIM COMMANDS.....	184
43	9.4.1	Security-related Commands	184
44	9.4.2	OTASP/OTAPA-related Commands	187
45	9.4.3	ESN Management Commands.....	194

1	9.4.4	Packet Data security-related Commands	196
2	9.4.5	BCMCS-related Commands	196
3	9.4.6	Application Authentication Commands	196
4	9.4.7	AKA-related Commands	197
5	9.4.8	LCS-related Commands	197
6	10.	DESCRIPTION OF SERVICES-RELATED PROCEDURE	204
7	10.1	IP-BASED LOCATION SERVICES PROCEDURES [50]	204
8	10.1.1	Functionalities of CSIM and ME	204
9	10.1.2	Key Management	204
10		ANNEX A (INFORMATIVE) R-UIM/CSIM FILE MAPPING TABLE	206
11		ANNEX B (NORMATIVE)	207
12		ANNEX D (NORMATIVE): TLS-RELATED TAG VALUES	209
13		ANNEX E (INFORMATIVE): SUGGESTED CONTENTS OF THE EFS AT PRE-PERSONALIZATION	210
14		ANNEX F (NORMATIVE): RESERVATION OF FILE IDENTIFIERS	217

15

Figures

1
2
3
4

Figure 1 CSIM Application Session Activation Procedures 208

Figure 2 CSIM Application Session Termination Procedures..... 208

Tables

1
2
3
4
5
6
7
8
9
10
11

Table 1 Coding of additional Instruction Byte of the Commands for a CSIM..... 181

Table 2 Coding of P2 of Manage SSD Command 185

Table 3 Coding of P2 of Authenticate Command 186

Table 4 Coding of P2 of Generic Key Command 187

Table 5 Coding of P2 of Generic Configuration Request 189

Table 6 Coding of P2 of Generic Download Request 191

Table 7 Coding of 'TLS Service Type' 200

Table 8 Summary of CSIM Files 210

FOREWORD

(This foreword is not part of this specification)

The present document defines the cdma2000^{®1} (CSIM) application. This application resides on the UICC, an IC card specified in [45]. In particular, [45] specifies the application independent properties of the UICC/terminal interface such as the physical characteristics and the logical structure.

¹ cdma2000[®] is the trademark for the technical nomenclature for certain specifications and standards of the Organizational Partners (OPs) of 3GPP2. Geographically (and as of the date of publication), cdma2000[®] is a registered trademark of the Telecommunications Industry Association (TIA-USA) in the United States.

1. INTRODUCTION

The present document defines the cdma2000^{®2} (CSIM) application. This application resides on the UICC, an IC card specified in [45]. In particular, [45] specifies the application independent properties of the UICC/terminal interface such as the physical characteristics and the logical structure.

6

² cdma2000[®] is the trademark for the technical nomenclature for certain specifications and standards of the Organizational Partners (OPs) of 3GPP2. Geographically (and as of the date of publication), cdma2000[®] is a registered trademark of the Telecommunications Industry Association (TIA-USA) in the United States.

1 **2. SCOPE**

2 The present document defines the cdma2000 application for cdma2000 network operation.

3 The present document specifies:

- 4 • Specific command parameters;
- 5 • File structures;
- 6 • Security functions;
- 7 • Interworking with other Applications (ISIM, USIM, etc....) on UICC
- 8 • Application protocol to be used on the interface between UICC (cdma2000 application)
- 9 and ME.

10 This is to ensure interoperability between a CSIM and an ME independently of the respective
11 manufacturer, card issuer or operator.

12 The present document does not define any aspects related to the administrative management
13 phase of the cdma2000 application. Any internal technical realization of either the cdma2000
14 application or the ME is only specified where these are reflected over the interface. The present
15 document does not specify any of the security algorithms that may be used.

16

3. REFERENCES

The following standards are referenced in this text. At the time of publication, the editions indicated were valid. All standards are subject to revision, and parties to agreements based upon this document are encouraged to investigate the possibility of applying the most recent editions of the standards indicated below. ANSI and TIA maintain registers of currently valid national standards published by them.

Normative:

1. 3GPP2 C.S0001-D v2.0, *Introduction to cdma2000 Spread Spectrum Systems*, October 2005.
2. 3GPP2 C.S0002-D v2.0, *Physical Layer Standard for cdma2000 Spread Spectrum Systems*, October, 2005.
3. Reserved.
4. 3GPP2 C.S0004-D v2.0, *Signaling Link Access Control (LAC) Standard for cdma2000 Spread Spectrum Systems*, October 2005.
5. 3GPP2 C.S0005-D v2.0, *Upper Layer (Layer 3) Signaling Standard for cdma2000 Spread Spectrum Systems*, October 2005.
6. Reserved.
7. 3GPP2 C.S0016-C v2.0, *Over-the-Air Service Provisioning of Mobile Stations in Spread Spectrum Systems*, October 2008.
8. C.S0015-B v2.0, *Short Message Service for Spread Spectrum Systems*, October 2005.
9. ITU-T Recommendation E.212, "Identification Plan for Land Mobile Stations", November 1998.
10. Reserved.
11. Reserved.
12. Reserved
13. Reserved
14. TIA-95-B, *Mobile Station - Base Station Compatibility Standard for Wideband Spread Cellular Systems*, October 2004.
15. 3GPP2 X.S0004-E V2.0, *Mobile Application Part*, July, 2005.
16. TIA/EIA/IS-91-A, *Base Station – Mobile Station Compatibility Specification for 800 MHz Cellular, Auxiliary, and Residential Services*, November 1999.
17. 3GPP TS 51.011 V4.15.0, *Specification of the Subscriber Identity Module-Mobile Equipment (SIM-ME) Interface*, June 2005.

- 1 18. ETSI TS 102 221 V8.1.0, *Smart cards; UICC-Terminal Interface; Physical and logical*
2 *Characteristics*, April 2009.
- 3 19. Reserved.
- 4 20. 3GPP2 S.S0053-0 v2.0 *Common Cryptographic Algorithms*, May 2009.
- 5 21. Reserved.
- 6 22. Reserved.
- 7 23. 3GPP2 X.S0011-D v2.0, *cdma2000 Wireless IP Network Standard*, November 2008.
- 8 24. IETF RFC 3344, *IP Mobility Support*, August 2002.
- 9 25. IETF RFC 2794, *Mobile IP Network Access Identifier Extension for IPv4*, March 2000.
- 10 26. IETF RFC 2865, *Remote Authentication Dial In User Service (RADIUS)*, June 2000.
- 11 27. IETF RFC 4721, *Mobile IPv4 Challenge/Response Extensions*, January 2007.
- 12 28. 3GPP2 C.S0024-B v2.0, *cdma2000 High Rate Packet Data Air Interface Specification*, April
13 2007.
- 14 29. 3GPP2 A.S0008-C v2.0, *Interoperability Specification (IOS) for High Rate Packet Data (HRPD)*
15 *Access Network Interfaces*, January 2009.
- 16 30. 3GPP TS 31.102 V8.6.0, *Characteristics of the Universal Subscriber Identity Module (USIM)*
17 *application*, June 2009.
- 18 31. 3GPP TS 31.103 V8.1.0, *Characteristics of the IP Multimedia Services Identity Module (ISIM)*
19 *Application*, June 2009.
- 20 32. 3GPP2 X.S0013-000-B v1.0, *All-IP Core Network Multimedia Domain - Overview* , December
21 2007.
- 22 33. IETF RFC 3261, *SIP: Session Initialization Protocol*, June 2002.
- 23 34. IETF RFC 4282, *The Network Access Identifier*, December 2005.
- 24 35. Reserved.
- 25 36. 3GPP2 S.S0083-A v1.0, *Broadcast-Multicast Service Security Framework*, September 2004.
- 26 37. 3GPP2 X.S0016-200-A v1.0, *MMS Stage-2, Functional Description*, February 2006.
- 27 38. 3GPP TS 23.038 V8.2.0, *Alphabets and language-specific information*, September 2008.
- 28 39. 3GPP2 X.S0016-310 v2.0, *MMS MM1 Stage-3 Using OMA/WAP*, July 2004.
- 29 40. 3GPP2 X.S0016-311-0 v1.0, *MMS MM1 Stage-3 Using M-IMAP for message submission and*
30 *retrieval*, May 2003.
- 31 41. 3GPP2 X.S0016-312-0 v1.0, *MMS MM1 Stage-3 Using SIP*, July 2004.

- 1 42. 3GPP2 S.S0055-A V4.0, *Enhanced Cryptographic Algorithms*, January 2008.
- 2 43. Reserved.
- 3 44. 3GPP2 C.S0068-0 v1.0, *ME Personalization*, June 2006.
- 4 45. 3GPP2 C.S0074-0 v1.0, *UICC-Terminal Interface Physical and Logical Characteristics for*
5 *cdma2000 Spread Spectrum Systems*, February 2009.
- 6 46. 3GPP2 C.S0023-C v2.0, *Removable User Identity Module for Spread Spectrum Systems*,
7 October 2008.
- 8 47. 3GPP2 C.S0035-A v2.0, *CDMA Card Application Toolkit (CCAT)*, August 2007.
- 9 48. ETSI TS 101 220 V8.4.0, *Smart cards; ETSI numbering system for telecommunication*
10 *application providers*, April 2009.
- 11 49. 3GPP TS 11.11 V8.14.0, "Specification of the Subscriber Identity Module - Mobile
12 Equipment (SIM-ME) Interface", June 2007.
- 13 50. S.S0110-0 v1.0, *IP-based Location Services Security Framework*, March 2006.
- 14 51. Reserved.
- 15 52. IETF RFC 5246, *The TLS Protocol Version 1.2*, August 2008.
- 16 53. ISO/IEC 7816-4, *Identification cards - Integrated circuit(s) cards with contacts,*
17 *Part 4: Interindustry commands for interchange*, October 2008.
- 18 54. ETSI TS 102 222 V7.1.0, *Administrative commands for telecommunications applications*,
19 February 2007.
- 20 55. Reserved.
- 21 56. Reserved.
- 22 57. Reserved.
- 23 58. ITU E.118 *The international telecommunication charge card*, February 2001.
- 24 59. ITU X.509, *Public-key and attribute certificate frameworks*, August 2005.
- 25 60. ITU X.690, *ASN.1 encoding rules: Specification of Basic Encoding Rules (BER), Canonical*
26 *Encoding Rules (CER) and Distinguished Encoding Rules (DER)*, November 2008.
27
28 *Editor's Note: The above document is a work in progress and should not be referenced unless*
29 *and until it is approved and published. Until such time as this Editor's Note is removed, the*
30 *inclusion of the above document is for informational purposes only.*
- 31 61. IETF RFC 2315, *PKCS #7: Cryptographic Message Syntax Version 1.5*, March 1998.
- 32 62. RSA PKCS #12 v1.0, *Personal Information Exchange Syntax*, March 1998.
- 33 63. IETF RFC 4489, *A Method for Generating Link-Scoped IPv6 Multicast Addresses*, April 2006.

- 1 64. IETF RFC 1738, *Uniform Resource Locators (URL)*, December 1994.
- 2 65. 3GPP2 C.S0017-012-A v1.0, *Data Service Options for Spread Spectrum Systems: Service*
3 *Options 33 and 66*, July, 2004.
- 4 66. ISO/IEC 7816-5, *Identification cards -- Integrated circuit cards -- Part 5: Registration of*
5 *application providers*, December 2004.
- 6 *Informative:*
- 7 1. 3GPP2 C.R1001-F v1.0, *Administration of Parameter Value Assignments for cdma2000*
8 *Wideband Spread Spectrum Standards*, December 2006.
- 9 2. 3GPP TS 31.101: "*UICC-Terminal Interface, Physical and Logical Characteristics*".
- 10 3. 3GPP TS 23.140: "*Multimedia Messaging Service (MMS); Functional description; stage 2*".

4. DEFINITIONS, SYMBOLS, ABBREVIATIONS AND CODING CONVENTIONS

For the purposes of the present document, the following terms and definitions apply:

AID. ISO/IEC 7816 Application Identifier. See [53/66].

CSIM. cdma2000 Subscriber Identify Module. cdma2000 Application residing on the UICC, an IC card specified in [45].

LCS. Location services.

LCS Root Key. LCS related parameter. See [50].

PIX. Proprietary application Identifier eXtension. See [53/66].

RID. Registered Application Provider Identifier. See [53/66].

R-UIM. Removable User Identity Module residing on a Non-UICC based platform, as specified in [46].

S-SAFE. Secure Store-And-Forward-Encapsulation. LCS related parameter. See [50].

TLS. Transport Layer Security.

All other definitions, symbols, abbreviations applicable to the R-UIM specified in [46] and UICC specified in [45] are applicable here.

The AID of CSIM is defined in [48/53] and is stored in EF_{DIR} . It is composed of the RID code 0xA000000343 and the PIX code, of which the first four digits are the 3G App Code 0x1002 indicating the “3GPP2 CSIM” application.

1 **5. FILES**

2 This section specifies the EFs for the CDMA operation defining access conditions, contents and
3 coding.

4 A file is associated with attributes that depending of the file type indicates how data is to be accessed
5 e.g. file size, record length etc. Although in the present document some files and data items stored in
6 a file are indicated as having a fixed length; when reading such structures the ME shall derive the
7 length of the data item from the attributes provided in the file information i.e. not use the fixed value
8 specified for the file in the present document. Although the ME is able to read the entire structure it
9 should only use those elements in the data item which is recognized by the ME.

10 For any EF, if the SFI is not indicated in the description of the file, then it is not allowed to assign an
11 SFI. If in the description of the file an SFI value is indicated, then the file shall support SFI. The SFI
12 value shall be assigned by the card issuer. It is mandatory for EFs stating an SFI value ('YY') in the
13 description of their structure to provide an SFI. For files where in the file description the SFI is
14 indicated as 'Optional', then the file may support an SFI.

15 [1] and [14] store parameters in several different types of memory. Variables stored in permanent
16 memory use the subscript "p". Variables stored in semi-permanent memory use the subscript "s-p".

17 **5.1 Contents of files at the MF level**

18 There are four application independent EFs at the Master File (MF) level as specified in [45], i.e.:
19 EF_{ICCID}, EF_{DIR}, EF_{PL} and EF_{ARR}.

20 See section 5.2.91 for some additional restrictions on the contents of EF_{ICCID}.

1 **5.2 Contents of files at the CSIM ADF (Application DF) level**

2 5.2.1 EF_{COUNT} (Call Count)

3 This EF stores the value of Call Count, COUNTs-p.

4

Identifier: '6F21'		Structure: cyclic		Mandatory	
Record Length: 2 bytes			Update activity: high		
Access Conditions:					
READ		PIN			
UPDATE		PIN			
INCREASE		PIN			
INVALIDATE		ADM			
REHABILITATE		ADM			
Bytes	Description			M/O	Length
1 - 2	COUNTs-p			M	2 bytes

5

6 COUNTs-p is contained in the least significant 6 bits of the two-byte field.

7

8 Coding:

9 Byte 1:

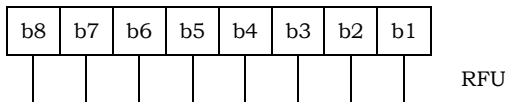

10

11 Byte 2:

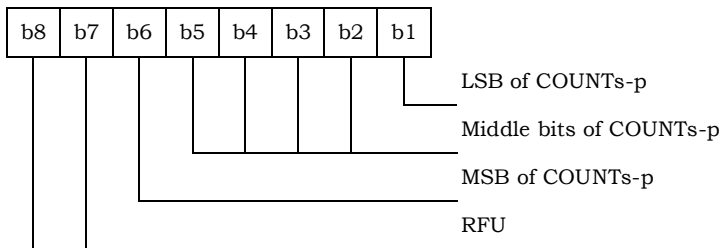

12

5.2.2 EF_{IMSI_M} (IMSI_M)

This EF stores the five components of IMSI_M.

Identifier: '6F22'		Structure: transparent		Mandatory	
SFI: '04'					
File size: 10 bytes			Update activity: low		
Access Conditions:					
READ		PIN			
UPDATE		ADM			
INVALIDATE		ADM			
REHABILITATE		PIN			
Bytes	Description	M/O	Length		
1	IMSI_M_CLASS _p	M	1 byte		
2 – 3	IMSI_M_S2 from IMSI_M_S _p	M	2 bytes		
4 – 6	IMSI_M_S1 from IMSI_M_S _p	M	3 bytes		
7	IMSI_M_11_12 _p	M	1 byte		
8	IMSI_M_PROGRAMMED/ IMSI_M_ADDR_NUM _p	M	1 byte		
9 –10	MCC_M _p	M	2 bytes		

- IMSI_M_CLASS_p - Class assignment of the IMSI_M.
- IMSI_M_ADDR_NUM_p - Number of IMSI_M address digits.
- MCC_M_p - Mobile country code.
- IMSI_M_11_12_p - 11th and 12th digits of the IMSI_M.
- IMSI_M_S_p - The least significant 10 digits of the IMSI_M.

Coding:

Byte 1:

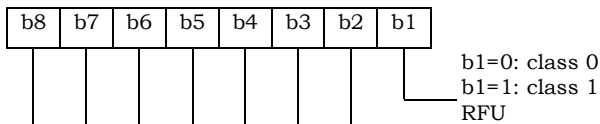

Byte 2, byte 3, byte 4, byte 5 and byte 6 are encoded as described in [14], Section 6.3.1.1, "Encoding of IMSI_M_S and IMSI_T_S".

1
2
3
4
5
6
7
8
9
10
11
12
13
14
15
16
17
18
19

Byte 2:

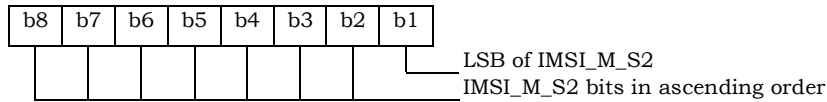

Byte 3:

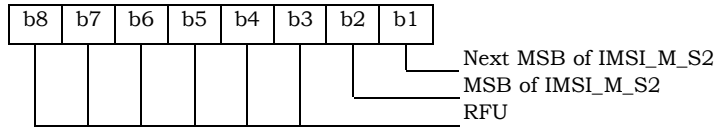

Byte 4:

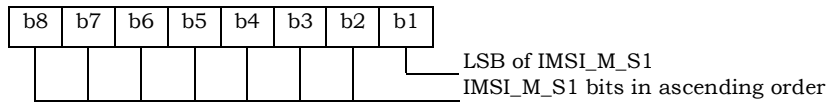

Byte 5:

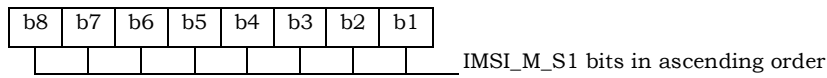

Byte 6:

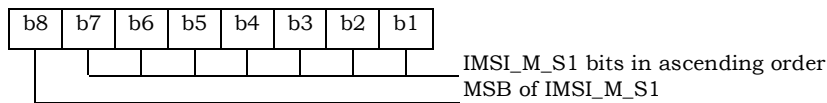

Byte 7 is encoded as described in [14], Section 6.3.1.2, “Encoding of IMSI_M_11_12 and IMSI_T_11_12”.

Byte 7:

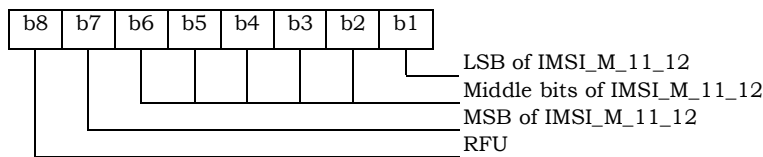

Byte 8 is the binary equivalent of the IMSI_M_ADD_NUM, as described in [14], Section 6.3.1, “Mobile Station Identification Number”.

Byte 8:

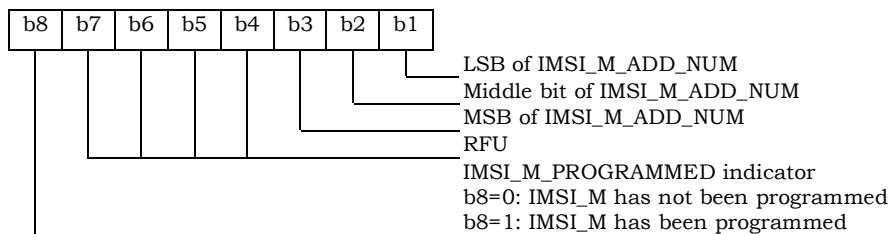

1
2
3
4
5
6
7
8
9
10
11
12
13
14
15
16
17
18
19
20
21
22

IMSI_M_PROGRAMMED shall be set to '1' if an IMSI_M has been programmed (IMSI_M would contain a MIN for systems that comply with [14]); if an IMSI_M has not been programmed, it shall be set to '0'.

Byte 9 and byte 10 are encoded as described in [14] Section 6.3.1.3, "Encoding of the MCC_M and MCC_T".

Byte 9:

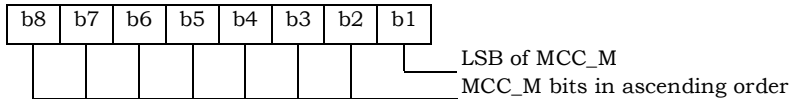

Byte 10:

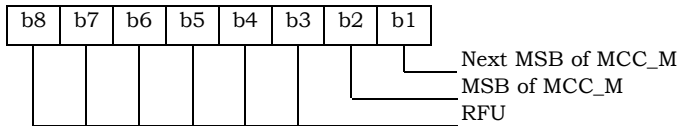

For CSIM applications in systems that comply with [14], the parameter "MIN" is stored in EF_{IMSI_M}. For these instances, the 10 bits of "MIN2" are stored in bytes 2 and 3, with the coding shown above, while the 24 bits of "MIN1" are stored in bytes 4, 5, and 6.

The selection of IMSI_M or IMSI_T for use in the authentication process shall be in accordance with [14] Section 6.3.12.1 and [5] Section 2.3.12.1, which stipulate that the "MIN" portion of IMSI_M shall be used as an input parameter of the authentication calculation if IMSI_M is programmed and that a 32-bit subset of IMSI_T shall be used if only IMSI_T has been programmed.

1 5.2.3 EF_{IMSL_T} (IMSI_T)

2 This EF stores the five components of IMSI_T.

3

Identifier: '6F23'		Structure: transparent		Mandatory
SFI: '05'				
File size: 10 bytes		Update activity: low		
Access Conditions:				
READ		PIN		
UPDATE		ADM		
INVALIDATE		ADM		
REHABILITATE		PIN		
Bytes	Description	M/O	Length	
1	IMSI_T_CLASS _p	M	1 byte	
2 – 3	IMSI_T_S2 from IMSI_T_S _p	M	2 bytes	
4 – 6	IMSI_T_S1 from IMSI_T_S _p	M	3 bytes	
7	IMSI_T_11_12 _p	M	1 byte	
8	IMSI_T_PROGRAMMED/ IMSI_T_ADDR_NUM _p	M	1 byte	
9 –10	MCC_T _p	M	2 bytes	

4

5 All byte descriptions, encodings and reference sections in [14] are identical to those described in

6 Section 5.2.2 EF_{IMSL_M}, except that all references to “IMSI_M” shall apply to “IMSI_T”.

7 EF_{IMSL_T} is not used to store a MIN.

8

5.2.4 EF_{TMSI} (TMSI)

This EF stores the Temporary Mobile Station Identity (TMSI). TMSI is assigned by the serving network and consists of 4 components, i.e.: ASSIGNING_TMSI_ZONE_LEN_{s-p}, ASSIGNING_TMSI_ZONE_{s-p}, TMSI_CODE_{s-p}, and TMSI_EXP_TIME_{s-p}.

Identifier: '6F24'		Structure: transparent		Mandatory	
SFI: '06'					
File size: 16 bytes			Update activity: high		
Access Conditions:					
READ		PIN			
UPDATE		PIN			
INVALIDATE		ADM			
REHABILITATE		PIN			
Bytes	Description	M/O	Length		
1	ASSIGNING_TMSI_ZONE_LEN _{s-p}	M	1 byte		
2 – 9	ASSIGNING_TMSI_ZONE _{s-p}	M	8 bytes		
10 – 13	TMSI_CODE _{s-p}	M	4 bytes		
14 – 16	TMSI_EXP_TIME _{s-p}	M	3 bytes		

Coding:

Byte 1:

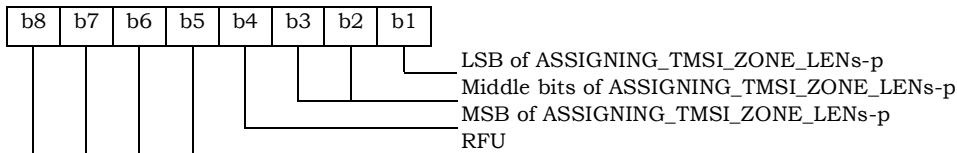

Bytes 2 through 9 store the (up to) 8-octet TMSI Zone as described in Sections 6.3.15, 6.3.15.1 and 6.3.15.2 of [14]. These sections are entitled “Temporary Mobile Station Identity”, “Overview” and “TMSI Assignment Memory” respectively. In each case the lowest-order octet shall be stored in the lowest-order byte (i.e., byte 2) of each set of contiguous 8 bytes, and successively higher octets stored in the next highest order bytes. Unused bytes shall be set to ‘00’.

Bytes 10 through 13 store the (2 to 4 octet) TMSI Code as described in the sections of [14] referenced above. In each case the lowest-order octet shall be stored in the lowest-order byte (i.e., byte 10) of each set of contiguous 4 bytes, and successively higher octets stored in the next highest order bytes. Unused bytes shall be set to ‘00’.

Bytes 14 through 16 store the TMSI Expiration Time as described in the sections of [14] referenced above. In each case the lowest-order octet shall be stored in the lowest-order byte (i.e.,

1 byte 14) of each set of contiguous 3 bytes, and successively higher octets stored in the next
2 highest order bytes.

3

1 5.2.5 EF_{AH} (Analog Home SID)

2 This EF identifies the home SID when the mobile station is operating in the analog mode.

3

Identifier: '6F25'		Structure: transparent		Mandatory
File size: 2 bytes			Update activity: low	
Access Conditions:				
READ		PIN		
UPDATE		PIN		
INVALIDATE		ADM		
REHABILITATE		ADM		
Bytes	Description	M/O	Length	
1-2	Analog home SID (HOME_SID _p)	M	2 bytes	

4

5 Coding:

6

Byte 1:

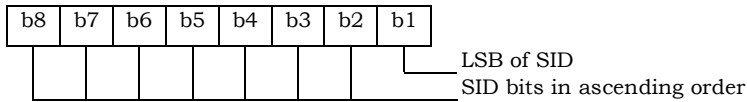

7

8

9

Byte 2:

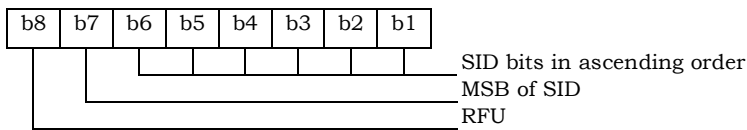

11

12

1 5.2.6 EF_{AOP} (Analog Operational Parameters)

2 This EF includes the Extended Address bit (EX_p), the Local Use Mark (LCM) and the Group ID
 3 (GID) field.

4

Identifier: '6F26'		Structure: transparent		Mandatory	
File size: 1 byte			Update activity: low		
Access Conditions:					
READ		PIN			
UPDATE		PIN			
INVALIDATE		ADM			
REHABILITATE		ADM			
Bytes	Description			M/O	Length
1	Analog Operational Parameters (EX _p , LCM, GID)			M	1 byte

5

6 Coding:

7

Byte 1:

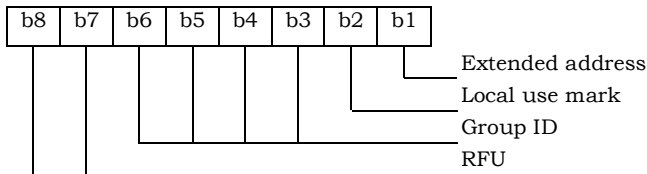

8

9

1 5.2.7 EF_{ALLOC} (Analog Location and Registration Indicators)

2 This EF stores parameters related to Autonomous Registration memory (NXTREGs-p and SIDs-p)
 3 as well as the Location Area memory (LOCAIDs-p and PUREGs-p).

4

Identifier: '6F27'		Structure: transparent		Mandatory	
File size: 7 bytes			Update activity: high		
Access Conditions:					
READ		PIN			
UPDATE		PIN			
INVALIDATE		ADM			
REHABILITATE		ADM			
Bytes	Description			M/O	Length
1-3	NXTREG _{s-p}			M	3 bytes
4-5	SID _{s-p}			M	2 bytes
6-7	LOCAID _{s-p} , PUREG _{s-p}			M	2 bytes

5

6 Coding:

7

Byte 1:

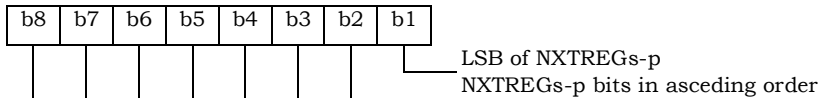

8

Byte 2:

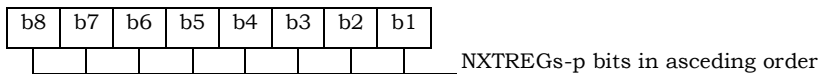

9

Byte 3:

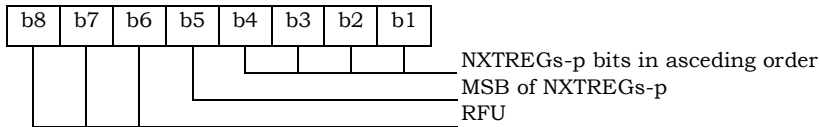

10

11

Byte 4:

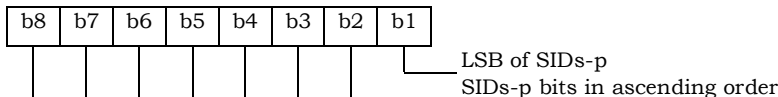

12

13

14

1

Byte 5:

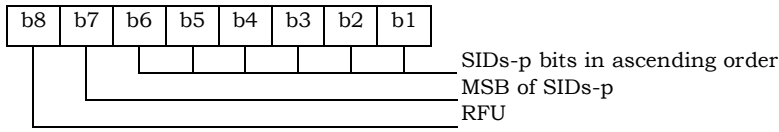

2

3

Byte 6:

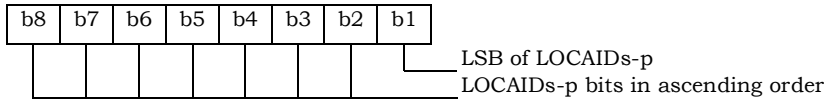

4

5

Byte 7:

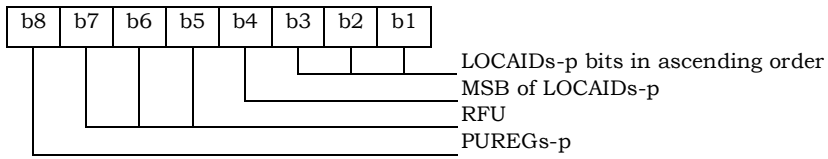

6

7

1 5.2.8 EF_{CDMAHOME} (CDMA Home SID, NID)

2 This EF identifies the home SID and NID when the mobile station is operating in the CDMA mode.

3

Identifier: '6F28'		Structure: linear fixed		Mandatory	
SFI: '0C'					
Record length: 5 bytes			Update activity: low		
Access Conditions:					
READ		PIN			
UPDATE		PIN			
INVALIDATE		ADM			
REHABILITATE		ADM			
Bytes	Description	M/O	Length		
1 – 2	CDMA Home SID (SID _p)	M	2 bytes		
3 – 4	CDMA Home NID (NID _p)	M	2 bytes		
5	Band Class	M	1 byte		

4

5 Coding:

6

Byte 1:

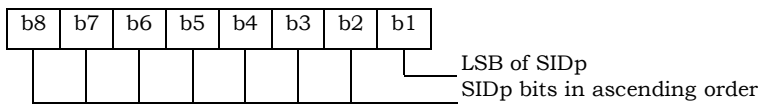

7

8

Byte 2:

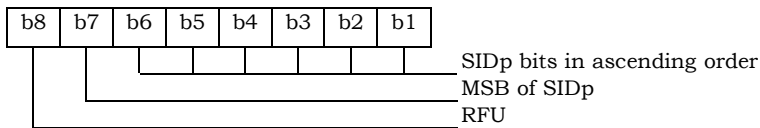

9

10

Byte 3:

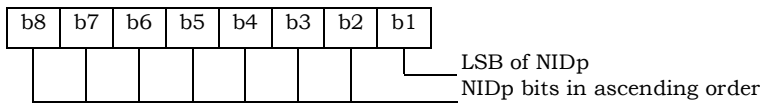

11

12

Byte 4:

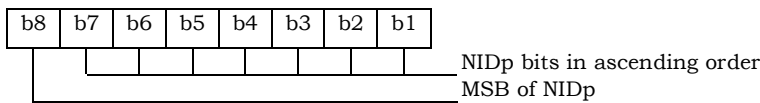

13

1

Byte 5:

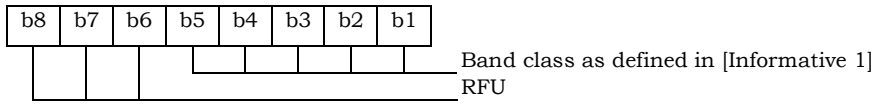

2

3

5.2.9 EF_{ZNREGI} (CDMA Zone-Based Registration Indicators)

This EF stores the zone-based registration list “ZONE_LIST”. The list includes a REG_ZONE and a corresponding SID, NID pair. Details are described in sections titled “Registration Memory”, “Zone-Based Registration” and “Registration Procedures” of [15/14].

Identifier: ‘6F29’		Structure: linear fixed		Mandatory	
Record length: 8 bytes			Update activity: high		
Access Conditions:					
READ		PIN			
UPDATE		PIN			
INVALIDATE		ADM			
REHABILITATE		ADM			
Bytes	Description	M/O	Length		
1 – 2	REG_ZONE	M	2 bytes		
3 – 4	SID	M	2 bytes		
5 – 6	NID	M	2 bytes		
7 – 8	RFU	M	2 bytes		

Coding:

Byte 1:

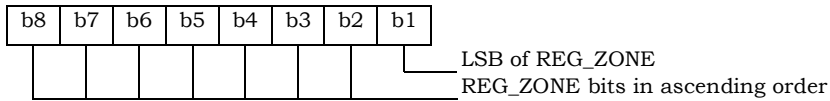

Byte 2:

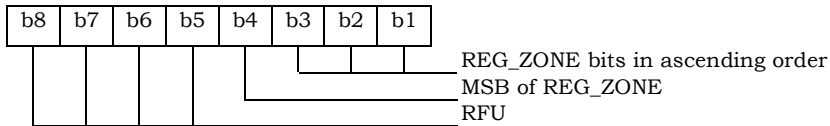

Byte 3:

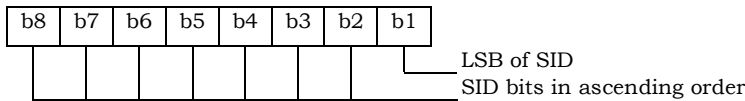

Byte 4:

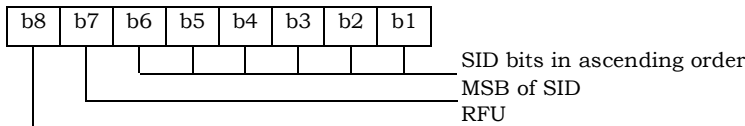

1

Byte 5:

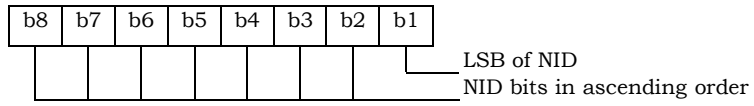

2

3

Byte 6:

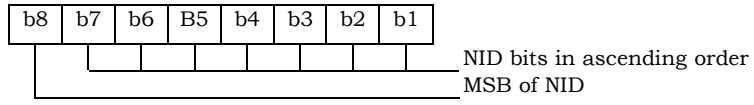

4

5

5.2.10 EF_{SNREGI} (CDMA System-Network Registration Indicators)

This EF stores the SID and NID of the wireless system in which the mobile station last registered. This is described in sections of [14] titled “Registration Memory” and “Zone-Based Registration”, respectively.

Identifier: '6F2A'		Structure: transparent		Mandatory	
SFI: '0D'					
File size: 7 bytes			Update activity: high		
Access Conditions:					
READ		PIN			
UPDATE		PIN			
INVALIDATE		ADM			
REHABILITATE		ADM			
Bytes	Description			M/O	Length
1	N, size of SID/NID list (N=1)			M	1 byte
2 – 3	SID			M	2 bytes
4 – 5	NID			M	2 bytes
6 – 7	RFU			M	2 bytes

Coding:

Byte 1:

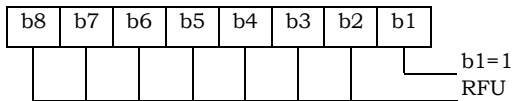

Byte 2:

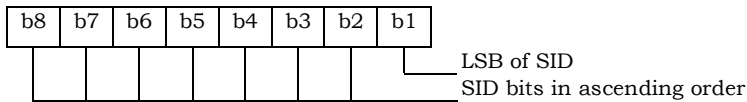

Byte 3:

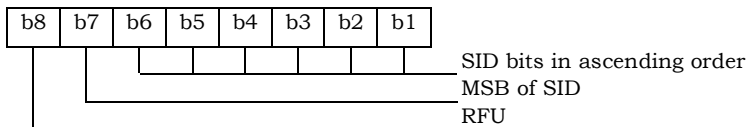

1

Byte 4:

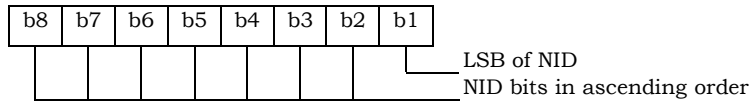

2

3

Byte 5:

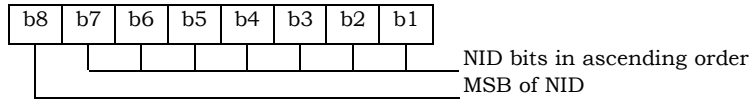

4

5

5.2.11 EF_{DISTREG} (CDMA Distance-Based Registration Indicators)

This EF stores the Base Station Latitude (BASE_LAT_REG), the Base Station Longitude (BASE_LONG_REG) and the Registration Distance (REG_DIST_REG) of the base station to which the first access probe (for a Registration Message, Origination Message or Page Response Message) was transmitted after entering the System Access State.

Identifier: '6F2B'		Structure: transparent		Mandatory	
File size: 8 bytes			Update activity: high		
Access Conditions:					
READ		PIN			
UPDATE		PIN			
INVALIDATE		ADM			
REHABILITATE		ADM			
Bytes	Description	M/O	Length		
1-3	BASE_LAT_REG	M	3 bytes		
4-6	BASE_LONG_REG	M	3 bytes		
7-8	REG_DIST_REG	M	2 bytes		

Coding:

Byte 1:

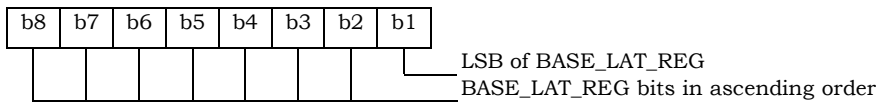

Byte 2:

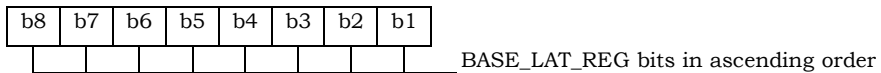

Byte 3:

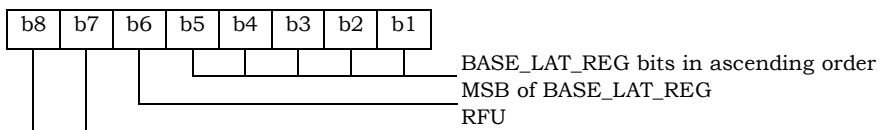

Byte 4:

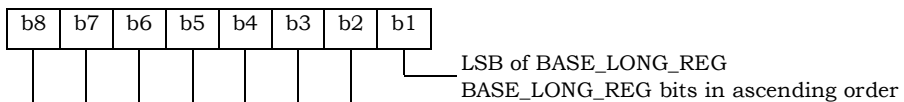

1

Byte 5:

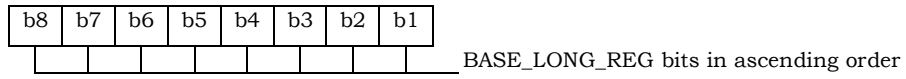

2

3

Byte 6:

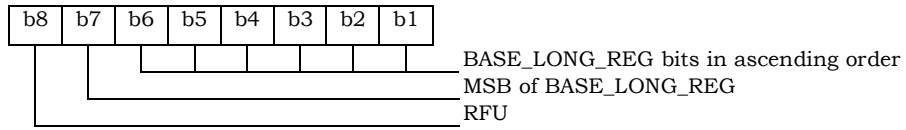

4

5

Byte 7:

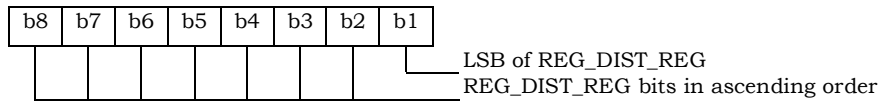

6

7

Byte 8:

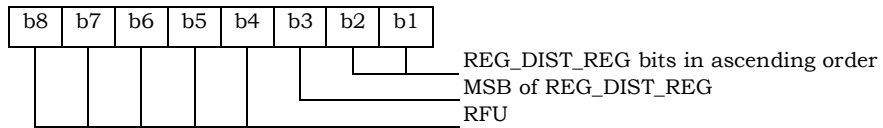

8

9

NOTE: The parameters for Distance-Based Registration are described in [14], Section 6.6.5.1.4.

10

11

1 5.2.12 EF_{ACCOLC} (Access Overload Class ACCOLC_p)

2 This EF defines the access overload class for the mobile station. This access overload class
 3 identifies which overload class controls access attempts by the mobile station and is used to
 4 identify redirected overload classes in global service redirection. For normal mobile stations, the 4-
 5 bit access overload class indicator is derived from the last digit of the associated decimal
 6 representation of the IMSI_M via decimal to binary conversion as specified in [5] and [14].

7

Identifier: '6F2C'		Structure: transparent		Mandatory	
SFI: '03'					
File size: 1 byte			Update activity: low		
Access Conditions:					
READ		PIN			
UPDATE		ADM			
INVALIDATE		ADM			
REHABILITATE		ADM			
Bytes	Description			M/O	Length
1	Access overload class (ACCOLC _p)			M	1 byte

8

9 Coding:

10 Byte 1:

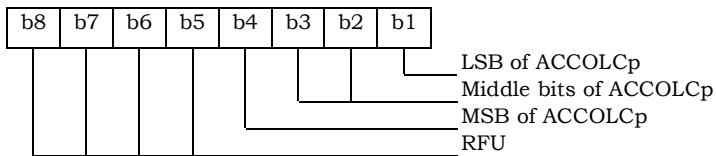

11

12

1 5.2.13 EF_{TERM} (Call Termination Mode Preferences)

2 This EF contains the call termination preference MOB_TERM_HOME_p, MOB_TERM_SID_p and
 3 MOB_TERM_FOR_NID_p.

4

Identifier: '6F2D'		Structure: transparent		Mandatory	
File size: 1 byte			Update activity: low		
Access Conditions:					
READ		PIN			
UPDATE		PIN			
INVALIDATE		ADM			
REHABILITATE		ADM			
Bytes	Description			M/O	Length
1	Call termination preferences			M	1 byte

5

6 Coding:

7

Byte 1:

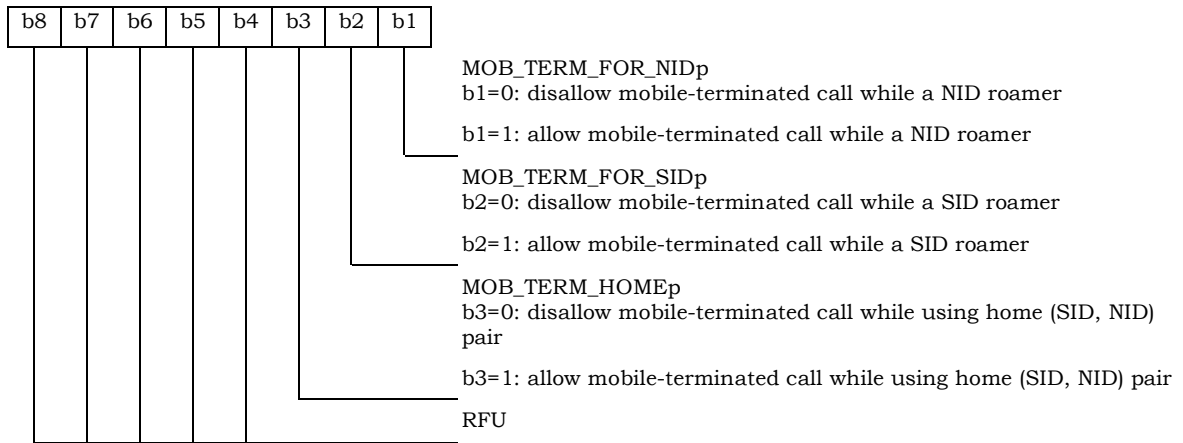

8

9

1 5.2.14 EF_{SSCI} (Suggested Slot Cycle Index)

2 This EF suggests a value for the mobile station’s preferred slot cycle index for CDMA operation
 3 (see 6.3.11 of [14]). Since the mobile equipment may not support all the slot cycle indexes, the
 4 mobile equipment shall select the minimum, as the preferred slot cycle index defined in [5],
 5 between the slot cycle index supported by the mobile equipment and the suggested slot cycle index
 6 contained in the EF_{SSCI}.

7

Identifier: ‘6F2E’		Structure: transparent		Optional	
File size: 1 byte			Update activity: low		
Access Conditions:					
READ		PIN			
UPDATE		PIN			
INVALIDATE		ADM			
REHABILITATE		ADM			
Bytes	Description			M/O	Length
1	Suggested slot cycle index			M	1 byte

8

9 Coding:

10 Byte 1:

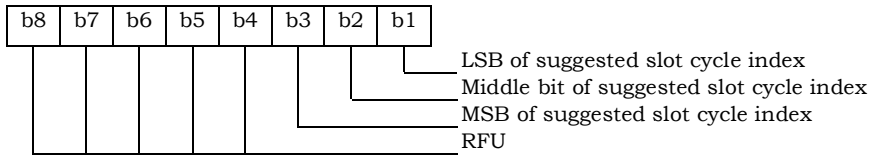

11

12

5.2.15 EF_{ACP} (Analog Channel Preferences)

This EF specifies the analog mode channel preferences as determined by the service provider in accordance with the terms of the subscription. The items addressed are the Analog Initial Paging Channel, the Analog First Dedicated Control Channel for System A, the Analog First Dedicated Control Channel for System B, and the Number of Dedicated Control Channels to scan.

Identifier: '6F2F'		Structure: transparent		Mandatory	
File size: 7 bytes			Update activity: low		
Access Conditions:					
READ		PIN			
UPDATE		PIN			
INVALIDATE		ADM			
REHABILITATE		ADM			
Bytes	Description	M/O	Length		
1-2	Analog Initial Paging Channel	M	2 bytes		
3-4	Analog First Dedicated Control Channel System A	M	2 bytes		
5-6	Analog First Dedicated Control Channel System B	M	2 bytes		
7	Number of Dedicated Control Channel to Scan	M	1 byte		

NOTE: Each channel is represented by an 11-bit binary number.

Coding:

Byte 1, 3, 5:

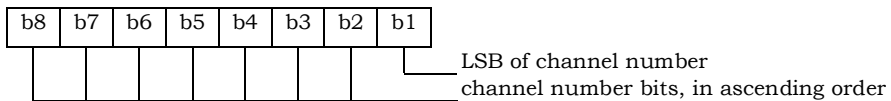

Byte 2, 4, 6:

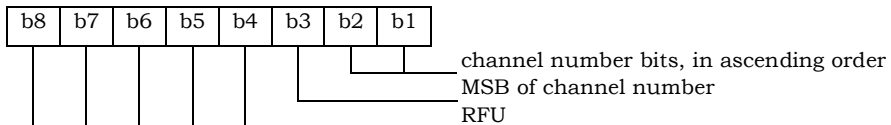

1 5.2.16 EF_{PRL} (Preferred Roaming List)

2 This EF stores the Preferred Roaming List, as described in Section 3.5.3 of [7]. The Preferred
 3 Roaming List includes selection parameters from [5] and [14].

4

Identifier: '6F30'		Structure: transparent		Mandatory	
SFI: '07'					
File size: 'MAX_PR_LIST_SIZE'			Update activity: low		
Access Conditions:					
READ		PIN			
UPDATE		ADM			
INVALIDATE		ADM			
REHABILITATE		ADM			
Bytes	Description			M/O	Length
1- PR_LIST_S IZE	PR_LIST (see Section 3.5.5 of [7])			M	PR_LIST_SIZE

5

1 5.2.17 EF_{RUIMID} (UIM_ID)

2 This EF stores a 32-bit electronic identification number (ID) unique to the CSIM or a 32-bit
 3 pseudo-UIMID of the CSIM. The file may store a 32-bit pseudo-UIMID constructed in the following
 4 way: The most significant 8 bits shall be 0x80. The least significant 24 bits shall be the 24 least
 5 significant bits of SHA-1 digest of the entire E-UIMID, either LF_EUIMID or SF_EUIMID³ (based on
 6 service n34 in EF_{CST})⁴.

7

Identifier: '6F31'		Structure: transparent		Mandatory	
File size: 8 bytes			Update activity: low		
Access Conditions:					
READ		ALW			
UPDATE		Never			
INVALIDATE		Never			
REHABILITATE		Never			
Bytes	Description	M/O	Length		
1	Number of bytes	M	1 byte		
2	Lowest-order byte	M	1 byte		
3	:	M	1 byte		
4	:	M	1 byte		
5	:	M	1 byte		
6	:	O	1 byte		
7	:	O	1 byte		
8	Highest-order byte	O	1 byte		

8
9

³ Example: if the LF_EUIMID (ICCID) is (hexadecimal) 89 (MSB) 01 01 01 23 45 67 89 01 4F (LSB), the pseudo-UIMID is (hexadecimal) 80 (Byte 5) C5 D5 64 (Byte 2), and with Byte 1 set to 04; if the 56-bit SF_EUIMID is (hexadecimal) FF (MSB) 00 00 01 12 34 56 (LSB), the pseudo-UIMID is (hexadecimal) 80(Byte 5) 07 37 E1(Byte 2), and with Byte 1 set to 04.

⁴The EUIMID (either form) is loaded into a 512-bit SHA-1 input block, starting with bit 1 of this block, to produce an output, from which the least significant 24 bits are used as the least significant 24 bits of EF(RUIMID). The 4-bit digits of EUIMID are loaded in the order d1, d2, d3, d4...dn-1, dn. Numbering the SHA-1 input buffer bits from 1 (first loaded) upwards, for each digit the most significant bit is loaded into the lowest numbered of four consecutive SHA-1 input bits and the least significant bit into the highest.

1 5.2.18 EF_{CST} (CSIM Service Table)

2 This EF indicates which services are available, If a service is not indicated as available in the
 3 CSIM, the ME shall not select this service.

4

Identifier: '6F32'		Structure: transparent		Mandatory
SFI: '02'				
File size: X bytes, X>=1		Update activity: low		
Access Conditions:				
READ		PIN		
UPDATE		ADM		
INVALIDATE		ADM		
REHABILITATE		ADM		
Bytes	Description	M/O	Length	
1	Services n1 to n8	M	1 byte	
2	Services n9 to n16	O	1 byte	
3	Services n17 to n24	O	1 byte	
4	Services n25 to n32	O	1 byte	
:	:	:	:	
X	Services n(8X-7) to n(8X)	O	1 byte	

5

6

Services:		
Service n1 :	Local Phone book	
Service n2 :	Fixed Dialing Numbers (FDN)	
Service n3 :	Extension 2	
Service n4 :	Service Dialing Numbers (SDN)	
Service n5 :	Extension 3	
Service n6 :	Short Message Storage (SMS)	
Service n7 :	Short Message Parameters	
Service n8 :	HRPD	
Service n9 :	Service Category Program for BC-SMS	
Service n10 :	CDMA Home Service Provider Name	
Service n11 :	Data Download via SMS Broadcast	

Service n12 :	Data Download via SMS-PP
Service n13 :	Call Control
Service n14 :	3GPD-SIP
Service n15 :	3GPD-MIP
Service n16 :	AKA
Service n17 :	IP-based Location Services (LCS)
Service n18 :	BCMCS
Service n19 :	Multimedia Messaging Service (MMS)
Service n20 :	Extension 8
Service n21 :	MMS User Connectivity Parameters
Service n22 :	Application Authentication
Service n23 :	Group Identifier Level 1
Service n24 :	Group Identifier Level 2
Service n25 :	De-Personalization Control Keys
Service n26 :	Cooperative Network List
Service n27 :	Outgoing Call Information (OCI)
Service n28 :	Incoming Call Information (ICI)
Service n29 :	Extension 5
Service n30 :	Multimedia Storage
Service n31 :	Image (EF _{IMG})
Service n32:	Enabled Services Table
Service n33:	Capability Configuration Parameters (CCP)
Service n34:	SF_EUIMID-based EUIMID
Service n35:	Messaging and 3GPD Extensions
Service n36:	Root Certificates
Service n37:	WAP Browser
Service n38:	Java
Service n39:	Reserved for CDG
Service n40:	Reserved for CDG

	Service n41:	IPv6
--	--------------	------

1
2
3
4
5
6
7
8
9
10
11
12
13
14
15
16
17
18
19
20
21
22

The EF shall contain at least one byte. Further bytes may be included, but if the EF includes an optional byte, then it is mandatory for the EF to also contain all bytes before that byte. Other services are possible in the future and will be coded on further bytes in the EF. The coding falls under the responsibility of the 3GPP2.

Coding:

1 bit is used to code each service:
 bit = 1: service available;
 bit = 0: service not available.

- Service available means that the CSIM has the capability to support the service and that the service is available for the user of the CSIM unless the service is identified as "disabled" in EF_{EST}.
 Service not available means that the service shall not be used by the CSIM user, even if the CSIM has the capability to support the service.

First byte:

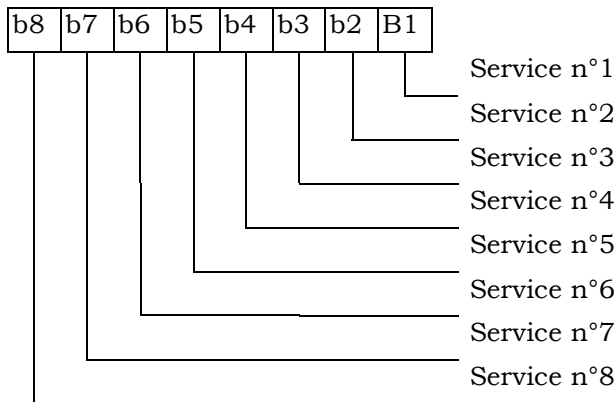

Second byte:

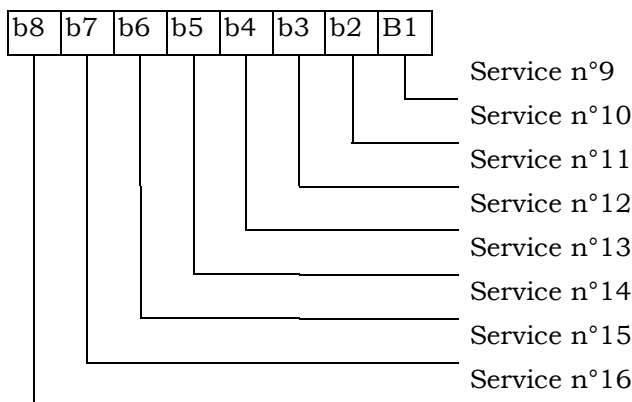

etc.

1

2 If the CSIM supports the FDN feature (FDN is enabled in EF_{EST}) a special mechanism shall exist in
3 the CSIM which invalidates **EF**_{IMSI_T}, **EF**_{IMSI_M} and **EF**_{TMSI} once during each CDMA session. This
4 mechanism shall be invoked by the CSIM automatically if FDN is enabled. This invalidation shall
5 occur at least before the next command following selection of either **EF**_{FDN} is enabled when the
6 ADN is invalidated or not available.

7 If service n34 (SF_EUIMID-based EUIMID) is not available, ME shall fill in EXT_UIM_ID INFO
8 RECORD with the entire contents of EF_{ICCID} in response to Status Request Message defined in [5].
9 Otherwise, ME shall fill in EXT_UIM_ID INFO RECORD with SF_EUIMID from EF_{SF_EUIMID}

10

11

1 5.2.19 EF_{SPC} (Service Programming Code)

2 This EF includes the Service Programming Code (SPC), having a value from 0 to 999,999. The
 3 default value is 0. Details of SPC are in [7] Section 3.3.6.

4

Identifier: '6F33'		Structure: transparent		Mandatory
File size: 3 bytes			Update activity: low	
Access Conditions:				
READ		ADM		
UPDATE		ADM		
INVALIDATE		ADM		
REHABILITATE		ADM		
Bytes	Description	M/O	Length	
1-3	Service Programming Code	M	3 bytes	

5

6 Coding:

7 SPC is a 6-digit number $D_1D_2D_3D_4D_5D_6$, where D_1 is the most significant digit and D_6 is the
 8 least significant digit. The coding of SPC in this EF is according to [7], Section 4.5.4.2,
 9 whereby each digit is encoded in BCD format.

10

11

Byte 1:

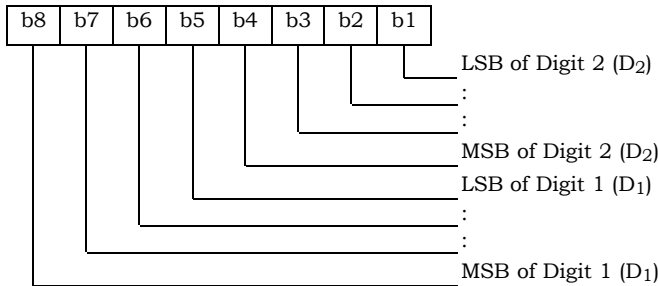

12

13

14

Byte 2:

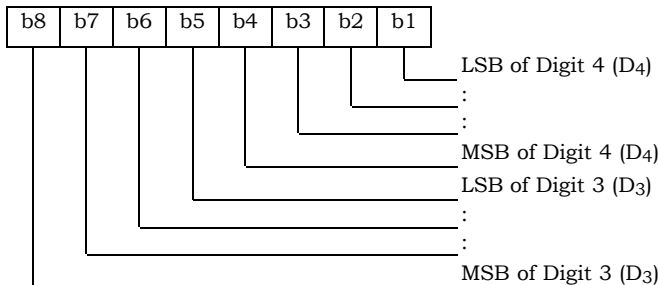

15

1

Byte 3:

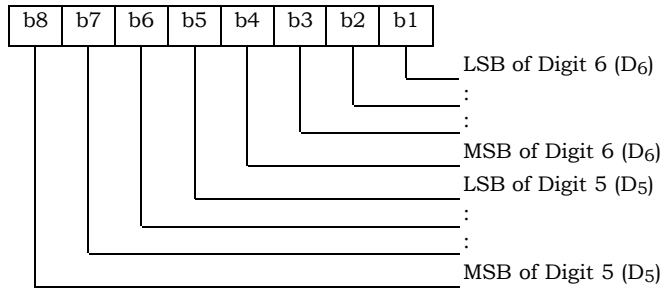

2

1 5.2.20 EF_{OTAPASPC} (OTAPA/SPC_Enabled)

2 This EF contains user-entered control information that either prevents or (else) permits network
 3 manipulation of the SPC, and either prevents or (else) permits OTAPA to be performed on the NAM.
 4 This EF is based upon information in [7], Sections 3.2.2 and 3.3.6. A successful base station
 5 response to an CSIM initiated challenge is required prior to any network manipulation of OTAPA
 6 accessible files.

7

Identifier: '6F34'		Structure: transparent		Mandatory	
File size: 1 byte			Update activity: low		
Access Conditions:					
READ		PIN			
UPDATE		PIN			
INVALIDATE		ADM			
REHABILITATE		ADM			
Bytes	Description			M/O	Length
1	OTAPA/SPC_Enable			M	1 byte

8

9 Coding:

10 Byte 1:

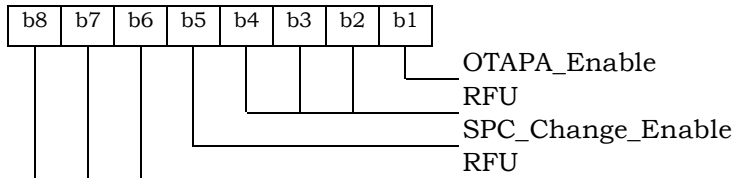

11

12 For "OTAPA_Enable", a value of '0' for the NAM indicates that the user consents to the
 13 performance of OTAPA for the NAM by the service provider. A value of '1' indicates that the user
 14 does not permit OTAPA to be performed on the NAM. Refer to [7], Section 3.2.2.

15 For "SPC_Change_Enable", a value of '0' for the CSIM indicates that the user consents to allow the
 16 service provider to change the value of the Service Programming Code. A value of '1' indicates that
 17 the user denies permission for the service provider to change the value of SPC.

18

5.2.21 EF_{NAMLOCK} (NAM_LOCK)

This EF stores the locked/unlocked state of the NAM. This EF is based upon information in [7].

Identifier: '6F35'	Structure: transparent	Mandatory	
File size: 1 byte	Update activity: low		
Access Conditions:			
READ	PIN		
UPDATE	PIN		
INVALIDATE	ADM		
REHABILITATE	ADM		
Bytes	Description	M/O	Length
1	SPASM protection indicator (NAM_LOCK) status	M	1 byte

Coding:

Byte 1:

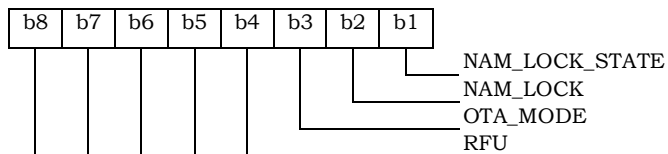

Bit 1 gives the current NAM_LOCK_STATE. A value of '1' indicates that the NAM is locked by the SPASM protection mechanism. A value of '0' indicates that the NAM is unlocked.

Bit 2 gives the permanent NAM_LOCK setting. A value of '1' indicates that the SPASM protection mechanism must be satisfied for network initiated OTA. A value of '0' indicates that SPASM protection is not required.

Bit 3 gives the OTA_MODE for the current OTA session. A value of '0' indicates user-initiated, and a value of '1' indicates network-initiated.

If an OTA programming session was initiated by the user as described in Section 3.2.1 of [7], SPASM does not protect access to the NAM parameters and indicators. In this case, the ME shall set the NAM_LOCK_STATE to '0.' The NAM_LOCK bit shall not be changed.

On invocation of a network-initiated OTA session, the ME shall set the NAM_LOCK_STATE=NAM_LOCK.

The ME updates the OTA_MODE bit to tell the CSIM how an OTA session was initiated. The ME shall set this bit on initiation of an OTA session. The CSIM shall comply with the requirements in [7] (e.g. shall reject OTAPA Request while in a user-initiated session.)

1 5.2.22 EF_{OTA} (OTASP/OTAPA Features)

2 This EF stores a listing of OTASP/OTAPA features supported by the CSIM, along with protocol
3 revision codes. This EF is a subset of the information in [7], Section 3.5.1.7.

4

Identifier: '6F36'		Structure: transparent		Mandatory
File size: 2N + 1 bytes		Update activity: low		
Access Conditions:				
READ		PIN		
UPDATE		ADM		
INVALIDATE		ADM		
REHABILITATE		ADM		
Bytes	Description	M/O	Length	
1	N, number of OTASP/OTAPA features	M	1 byte	
2	NAM Download (DATA_P_REV) ID	M	1 byte	
3	DATA_P_REV	M	1 byte	
4	Key Exchange (A_KEY_P_REV) ID	M	1 byte	
5	A_KEY_P_REV	M	1 byte	
6	System Selection for Preferred Roaming (SSPR_P_REV) ID	M	1 byte	
7	SSPR_P_REV	M	1 byte	
8	Service Programming Lock (SPL_P_REV) ID	M	1 byte	
9	SPL_P_REV	M	1 byte	
10	Over-The-Air Parameter Admin (OTAPA_P_REV) ID	M	1 byte	
11	OTAPA_P_REV	M	1 byte	
12	Preferred User Zone List (PUZL_P_REV) ID	M	1 byte	
13	PUZL_P_REV	M	1 byte	
14	3G Packet Data (3GPD) ID	M	1 byte	
15	3GPD	M	1 byte	
16	Secure MODE (SECURE_MODE_P_REV) ID	M	1 byte	
17	SECURE_MODE_P_REV	M	1 byte	
:	:	:	:	
2N	Feature N	M	1 byte	
2N + 1	Protocol Revision for Feature N	M	1 byte	

5

6 NOTE: Coding of features and protocol revisions are described in [7], Section 3.5.1.7.

7

1 5.2.23 EF_{SP} (Service Preferences)

2 This EF describes the user's service preferences as defined in [14] Sections 6.3.10.1 and 6.3.10.2.

3

Identifier: '6F37'		Structure: transparent		Mandatory
File size: 1 byte			Update activity: low	
Access Conditions:				
READ		PIN		
UPDATE		PIN		
INVALIDATE		ADM		
REHABILITATE		ADM		
Bytes	Description	M/O	Length	
1	Service Preferences (e.g. band class, analog vs. CDMA)	M	1 byte	

4

5 Coding:

6

Byte 1:

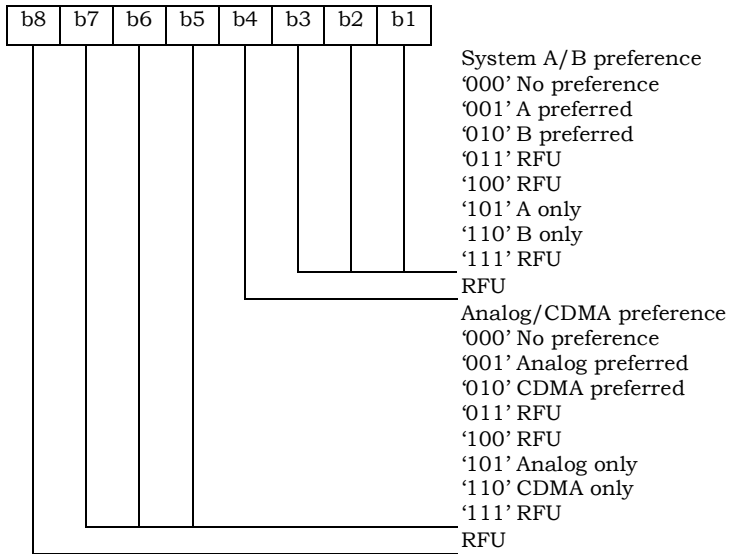

7

8

1 5.2.24 EF_{ESNME} (ESN_ME)

2 This EF stores the 32-bit Electronic Serial Number or 56-bit MEID or 32-bit-pseudo-ESN of the
 3 Mobile Equipment (ME) to which the CSIM is attached. This number is transferred to the CSIM
 4 when the ME determines that the CSIM has been inserted.

5

Identifier: '6F38'		Structure: transparent		Mandatory	
File size: 8 bytes			Update activity: low		
Access Conditions:					
READ		ALW			
UPDATE		ADM			
INVALIDATE		ADM			
REHABILITATE		ADM			
Bytes	Description	M/O	Length		
1	Number of bytes for ESN_ME	M	1 byte		
2	Lowest-order byte	M	1 byte		
3	:	M	1 byte		
4	:	M	1 byte		
5	:	M	1 byte		
6	:	M	1 byte		
7	:	M	1 byte		
8	Highest-order byte	M	1 byte		

6

7

1 5.2.25 Reserved

1 5.2.26 EF_{LI} (Language Indication)

2 This EF contains the codes for one or more languages. This information, determined by the
 3 user/operator, defines the preferred languages of the user in order of priority. This information
 4 may be used by the ME for MMI purposes.

5

Identifier: '6F3A'		Structure: transparent		Optional	
SFI: '0A'					
File size: 2N bytes			Update activity: low		
Access Conditions:					
READ		ALW			
UPDATE		PIN			
INVALIDATE		ADM			
REHABILITATE		ADM			
Bytes	Description	M/O	Length		
1 – 2	1 st language code (highest priority)	M	2 bytes		
3 – 4	2 nd language code	O	2 bytes		
:	:	:	:		
2N-1 – 2N	N th language code (lowest priority)	O	2 bytes		

6

7 Coding:

8

Byte 1:

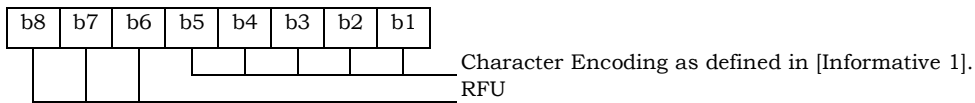

9

10

Byte 2:

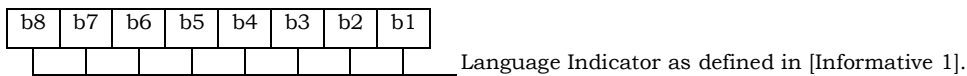

11

1 5.2.27 EF_{F_{DN}} (Fixed Dialling Numbers)

2 This EF contains Fixed Dialling Numbers (FDN) and/or Supplementary Service Control strings
 3 (SSC). In addition it contains identifiers of associated network/bearer capabilities and identifiers of
 4 extension records at the CSIM ADF level. It may also contain an associated alpha-tagging.

5

Identifier: '6F3B'		Structure: linear fixed		Optional	
Record length: X+14 bytes			Update activity: low		
Access Conditions:					
READ		PIN			
UPDATE		PIN2			
DEACTIVATE		ADM			
ACTIVATE		ADM			
Bytes	Description	M/ O	Length		
1 to X	Alpha Identifier	O	X bytes		
X+1	Length of BCD number/SSC contents	M	1 byte		
X+2	TON and NPI	M	1 byte		
X+3 to X+12	Dialling Number/SSC String	M	10 bytes		
X+13	Capability/Configuration2 (EF _{CCP2}) Record Identifier	M	1 byte		
X+14	Extension2 (EF _{EXT2}) Record Identifier	M	1 byte		

6
 7 For contents and coding of all data items, see the respective data items of the EF_{ADN} (Section
 8 5.4.1), with the exception that extension records are stored in the EF_{EXT2}.

9
 10 NOTE: The value of X (the number of bytes in the alpha-identifier) may be different to the length
 11 denoted X in EF_{ADN}.

5.2.28 EF_{SMS} (Short Messages)

This EF contains information in accordance with [8] comprising short messages (and associated parameters) which have either been received by the MS from the network or are to be used as an MS originated message.

Identifier: '6F3C'		Structure: linear fixed		Optional	
Record Length: variable (1)			Update activity: high		
Access Conditions:					
READ		PIN			
UPDATE		PIN			
INVALIDATE		ADM			
REHABILITATE		ADM			
Bytes	Description	M/O	Length		
1	Status	M	1 byte		
2	MSG_LEN	M	1 byte		
3 – 3+MSG_L EN	SMS Transport Layer Message	M	MSG_LEN bytes		

Note: (1) The length and the byte allocations are variable according to the actual size of the SMS Transport Layer message. The maximum length is 255, which includes the length of the short message plus two bytes for storing “status” and “MSG_LEN”.

- Status

Contents:

Status byte of the record which can be used as a pattern in the SEEK command. For MS originating messages sent to the network, the status shall be updated when the MS receives a status report or sends a successful SMS Command relating to the status report.

Coding:

1

Byte 1:

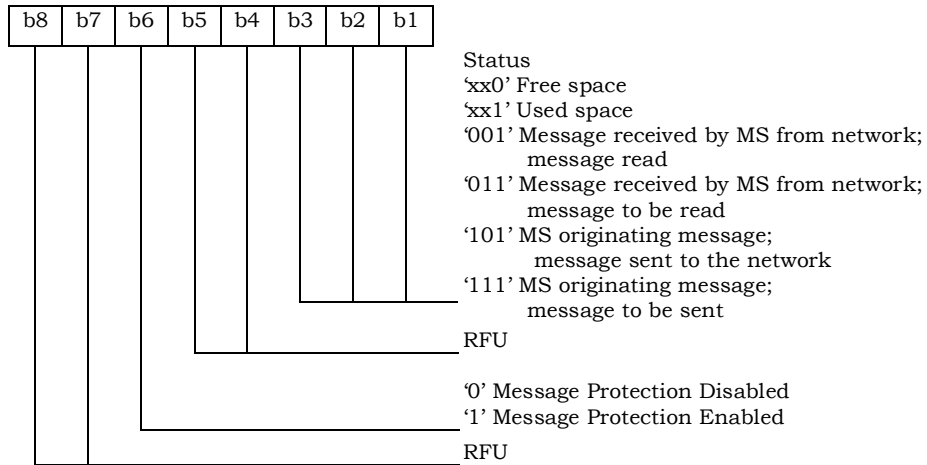

2

3

4

- MSG_LEN

5

Contents:

6

The length of the message, not including MSG_LEN. Note that the definition of this EF does allow multiple occurrences of the segment, which consists of "PARAMETER_ID", "PARAMETER_LEN", and "Parameter Data" as described in [8]. The number of repetitions of the aforementioned segment is determined by MSG_LEN and the PARAMETER_LEN of each segment.

11

12

- SMS Transport Layer Message

13

Contents: see Section 3.4.1 of [8].

14

5.2.29 EF_{SMS}P (Short Message Service Parameters)

This EF contains values for Short Message Service header Parameters (SMS_P), which can be used by the Mobile Equipment (ME) for user assistance in preparation of mobile originated short messages.

The EF consists of one or more records, with each record able to hold a set of SMS parameters. The first (or only) record in the EF shall be used as a default set of parameters, if no other record is selected. To distinguish between records, a four-byte Teleservice Identifier as defined in [8] shall be included within each record. The SMS parameters stored within a record may be present or absent independently. When a short message is to be sent from the Mobile Station (MS), the parameters in the CSIM record, if present, shall be used when a value is not supplied by the user.

Identifier: '6F3D'		Structure: linear fixed		Optional	
Record Length: variable			Update activity: high		
Access Conditions:					
READ		PIN			
UPDATE		PIN			
INVALIDATE		ADM			
REHABILITATE		ADM			
Bytes	Description	M/O	Length		
(1), (2)	Teleservice Identifier	M	4 bytes		
	Parameter Indicators	M	2 bytes		
	Reserved	M	1 byte		
	Destination Address	M	Variable (1)(3)		
	MSG_ENCODING	M	1 byte		
	Validity Period	M	1 byte		
	Service Category	O	4 bytes		
	Destination Subaddress	O	Variable (1)		
	Bearer Reply Option	O	3 bytes		
	Bearer Data	O	Variable (1)		

- Notes: (1) See [8].
 (2) Starting and ending bytes depend on (1)
 (3) If the Destination Address is absent, the parameter length is 1 byte.

Storage is allocated for all of the possible SMS parameters, regardless of whether they are present or absent. Any bytes unused, due to parameters not requiring all of the bytes, or due to absent parameters, shall be set to 'FF'.

The supported teleservices include [16] Extended Protocol Enhanced Services, Wireless Paging Teleservice, Wireless Messaging Teleservice, Voice Mail Notification and Wireless Application Protocol. See [8] for details.

- Parameter Indicators

Contents:

Each of the default SMS parameters which can be stored in the remainder of the record are marked absent or present by individual bits within this byte.

Coding:

Byte 5:

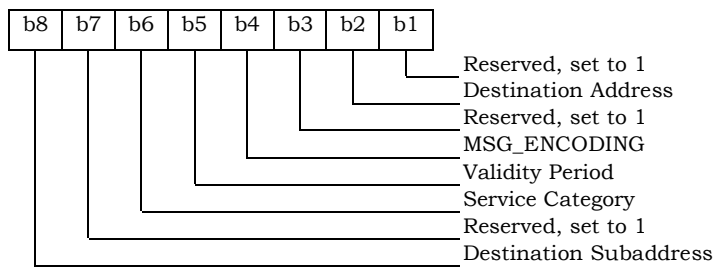

Byte 6:

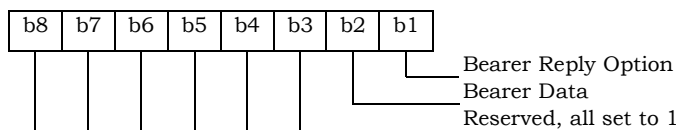

Note: Bit value 0 means parameter present
 Bit value 1 means parameter absent

- Destination Address

Contents and Coding: As defined in [8]. If this parameter is absent, then it shall be set to 'FF' with a length of 1 byte.

- MSG_ENCODING

Contents:

As defined in [Informative 1]. This parameter can appear in the Bearer Data if Bearer Data is present. If this parameter appears in the Bearer Data too, then the same value shall be set to this parameter; otherwise the record is invalid. If this parameter appears in the Bearer Data, then this parameter shall be present; otherwise the record is invalid.

1
2
3
4
5
6
7
8
9
10
11
12
13
14
15
16
17
18
19
20
21
22
23
24
25
26
27
28
29

Coding:

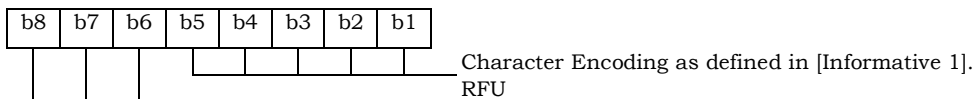

- Validity Period

Contents and Coding:

As defined in [8] for relative time format. This parameter can appear in the Bearer Data if Bearer Data is present. If this parameter appears in the Bearer Data too, then the same value shall be set to this parameter; otherwise the record is invalid. If this parameter appears in the Bearer Data, then this parameter shall be present; otherwise the record is invalid.

- Service Category

Contents and Coding: as defined in [8].

- Destination Subaddress

Contents and Coding: as defined in [8].

- Bearer Reply Option

Contents and Coding: as defined in [8].

- Bearer Data

Contents and Coding: as defined in [8].

1 5.2.30 EF_{SMSS} (SMS Status)

2 This EF contains status information relating to the short message service.

3 The provision of this EF is associated with EF_{SMS}. Both files shall be present together or both shall
4 be absent from the CSIM.

5

Identifier: '6F3E'		Structure: transparent		Optional	
File size: 5 + X bytes			Update activity: low		
Access Conditions:					
READ		PIN			
UPDATE		PIN			
INVALIDATE		ADM			
REHABILITATE		ADM			
Bytes	Description			M/O	Length
1 – 2	MESSAGE_ID			M	2 bytes
3 – 4	WAP MESSAGE_ID			M	2 bytes
5	SMS "Memory Cap. Exceeded" Notification Flag/SMS Timestamp Mode			M	1 byte
6-5 + X	Reserved			O	X bytes

6
7 - MESSAGE_ID

8 Contents:

9 The value of the MESSAGE_ID in the last sent *SMS Submit Message* from a teleservice
10 which requires message identifiers other than the WAP teleservice.

11 Coding: as defined in [8].

12
13
14
15 - WAP MESSAGE_ID

16 Contents:

17 The value of the MESSAGE_ID in the last sent *SMS Submit Message* from the WAP
18 teleservice.

19 Coding: as defined in [8].

20
21
22 - SMS "Memory Capacity Exceeded" Notification Flag/SMS Timestamp Mode.

23 Contents:

24 Includes a flag that indicates whether or not there is memory capacity available to store
25 SMS messages. Also includes a bit that indicates whether the SMS Timestamp mode is
26 UTC or non-UTC.

1 Coding:

2 Byte 5:

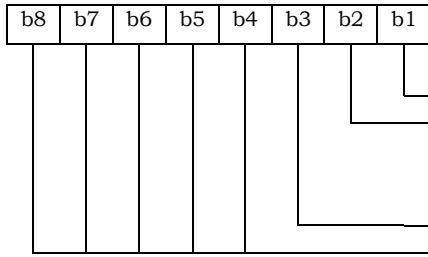

b1=0: flag set
b1=1: flag unset; memory capacity available
Reserved, set to 1
b3=0: SMS Timestamp mode is UTC.
b3=1: SMS Timestamp mode is non-UTC.
Note: The SMS Timestamp mode is configured by the service provider.
Reserved, all set to 1

3

1 5.2.31 EF_{SSFC} (Supplementary Services Feature Code Table)

2 This EF stores the numeric feature code to be used by the ME when a supplementary service is
3 invoked in CDMA or analog mode via an implementation-dependant user interface (such as a
4 menu) that automatically inserts a feature code into the dialed digit string. Because feature codes
5 are service-provider specific, this EF is required to enable the ME to perform the mapping to the
6 feature code.

7 When a supplementary service is invoked in CDMA or analog mode, the mobile station shall
8 determine the feature code by reading the Supplementary Service Feature Code Table entry for the
9 selected supplementary service, and pre-pending with asterisk.

10

Identifier: '6F3F'		Structure: transparent		Optional	
File size: 2N+1			Update activity: low		
Access Conditions:					
READ		PIN			
UPDATE		PIN			
INVALIDATE		ADM			
REHABILITATE		ADM			
Bytes	Description	M/O	Length		
1	N, Number of Feature Codes	M	1 byte		
2 – 3	Activate Call Delivery (CD)	M	2 bytes		
4 – 5	De-activate Call Delivery (CD)	M	2 bytes		
6 – 7	Register new Call Forwarding – Busy (CFB) forward-to number	M	2 bytes		
8 – 9	Register Call Forwarding – Busy (CFB) to voice mail	M	2 bytes		
10 – 11	De-register Call Forwarding – Busy (CFB)	M	2 bytes		
12 – 13	Activate Call Forwarding – Busy (CFB)	M	2 bytes		
14 – 15	De-activate Call Forwarding – Busy (CFB)	M	2 bytes		
16 – 17	Register new Call Forwarding – Default (CFD) forward-to number	M	2 bytes		
18 – 19	Register Call Forwarding – Default (CFD) to voice mail	M	2 bytes		
20 – 21	De-register Call Forwarding – Default (CFD)	M	2 bytes		
22 – 23	Activate Call Forwarding – Default (CFD)	M	2 bytes		
24 – 25	De- activate Call Forwarding – Default (CFD)	M	2 bytes		
26 – 27	Register new Call Forwarding – No Answer (CFNA) forward-to number	M	2 bytes		
28 – 29	Register Call Forwarding – No Answer (CFNA) to voice mail	M	2 bytes		
30 – 31	De-register Call Forwarding – No Answer (CFNA)	M	2 bytes		
32 – 33	Activate Call Forwarding – No Answer (CFNA)	M	2 bytes		
34 – 35	De-activate Call Forwarding – No Answer (CFNA)	M	2 bytes		
36 – 37	Register new Call Forwarding – Unconditional (CFU) forward-to number	M	2 bytes		
38 – 39	Register Call Forwarding – Unconditional (CFU) to voice mail	M	2 bytes		
40 – 41	De-register Call Forwarding – Unconditional (CFU)	M	2 bytes		
42 – 43	Activate Call Forwarding – Unconditional (CFU)	M	2 bytes		
44 – 45	De-activate Call Forwarding – Unconditional (CFU)	M	2 bytes		
46 – 47	Activate Call Waiting (CW)	M	2 bytes		
48 – 49	De-activate Call Waiting (CW)	M	2 bytes		

50 – 51	Temporarily De-activate Call Waiting (Cancel Call Waiting - CCW)	M	2 bytes
52 – 53	Temporarily Activate Calling Number Identification Restriction (CNIR) (per-call blocking)	M	2 bytes
54 – 55	Temporarily De-activate Calling Number Identification Restriction (CNIR) (per-call allowed)	M	2 bytes
56 – 57	Invoke Conference Calling (CC)	M	2 bytes
58 – 59	Invoke Drop Last Conference Calling (CC) Party	M	2 bytes
60 – 61	Activate Do Not Disturb (DND)	M	2 bytes
62 – 63	De-activate Do Not Disturb (DND)	M	2 bytes
64 – 65	Activate Message Waiting Notification (MWN) Alert Pip Tone	M	2 bytes
66 – 67	De-activate Message Waiting Notification (MWN) Alert Pip Tone	M	2 bytes
68 – 69	Activate Message Waiting Notification (MWN) Pip Tone	M	2 bytes
70 – 71	De-activate Message Waiting Notification (MWN) Pip Tone	M	2 bytes
72 – 73	Temporarily De-activate Message Waiting Notification (MWN) Pip Tone (Cancel MWN - CMWN)	M	2 bytes
74 – 75	Invoke Priority Access and Channel Assignment (PACA)	M	2 bytes
76 – 77	Invoke Voice Message Retrieval (VMR)	M	2 bytes
78 – 79	Activate Calling Name Presentation (CNAP)	M	2 bytes
80 – 81	De-activate Calling Name Presentation (CNAP)	M	2 bytes
82 – 83	Activate Calling Name Restriction (CNAR)	M	2 bytes
84 – 85	De-activate Calling Name Restriction (CNAR)	M	2 bytes
86 – 87	Activate Automatic Callback (AC)	M	2 bytes
88 – 89	De-activate Automatic Callback (AC)	M	2 bytes
90 – 91	Activate Automatic Recall (AR)	M	2 bytes
92 – 93	De-activate Automatic Recall (AR)	M	2 bytes
94 – 95	Register new network registered User Selectable Call Forwarding (USCF) directory number	M	2 bytes
96 – 97	Activate Rejection of Undesired Annoying Calls (RUAC)	M	2 bytes
98 – 99	De-activate Rejection of Undesired Annoying Calls (RUAC)	M	2 bytes
100 – 101	Invoke Advice of Charge (AOC)	M	2 bytes
102 – 103	Invoke Call Trace (COT)	M	2 bytes
2N – 2N+1	FCN	M	2 bytes

1 N, Number of Feature Codes" is coded in hexadecimal value, which indicates the number of
2 feature codes.

3 A feature code of up to four digits shall be encoded via BCD into the two bytes of the feature code
4 table entry as follows:

- 5 - represent these four digits as $D_1D_2D_3D_4$.
- 6 - if the feature code (FC) of less than four digits is used, the digits shall be right justified
7 and the unused digits shall be set to 'F'.

8
9 Coding:

10 First byte:

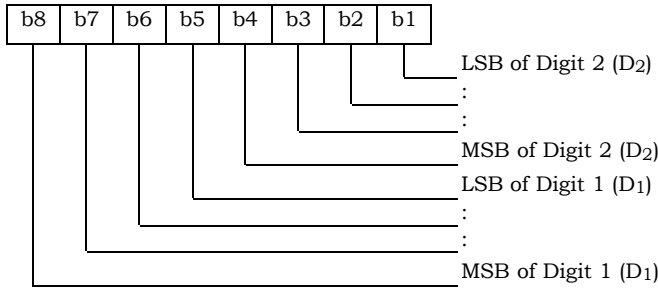

11

12 Second byte:

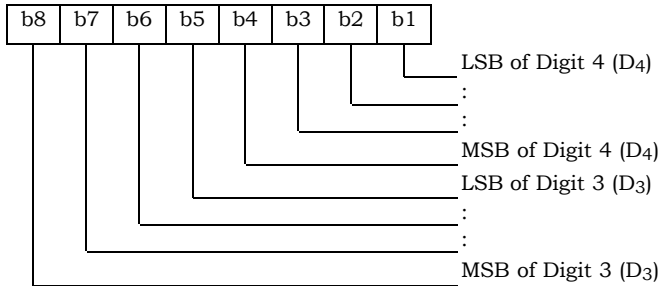

13

14

5.2.32 EF_{SPN} (CDMA Home Service Provider Name)

This EF contains the home service provider name and appropriate requirements for display by the ME.

Identifier: '6F41'		Structure: transparent		Optional	
SFI: '08'					
File size: 35 bytes			Update activity: low		
Access Conditions:					
READ		ALW			
UPDATE		ADM			
INVALIDATE		ADM			
REHABILITATE		ADM			
Bytes	Description	M/O	Length		
1	Display Condition	M	1 byte		
2	Character Encoding	M	1 byte		
3	Language Indicator	M	1 byte		
4 – 35	Service Provider Name	M	32 bytes		

- Display Condition
Contents:

An indication of whether or not a service provider name should be displayed when the MS is registered in the home service area.

Coding:

Byte 1:

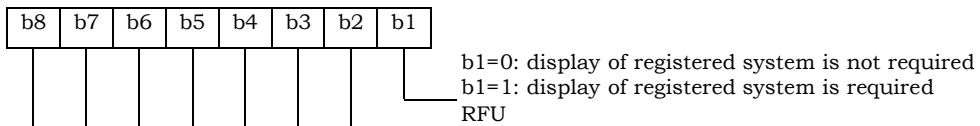

Byte 2:

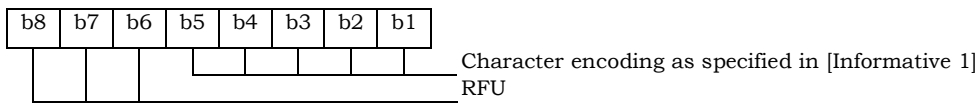

Byte 3:

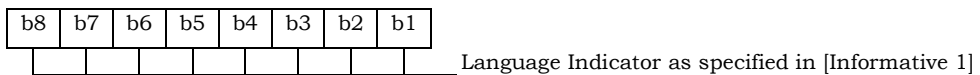

Byte 4 – 35:

- Service Provider Name

1 Contents: service provider string to be displayed.

2 Coding:

3 The string shall use SMS conventions as defined in Tables 9-1 and 9-2 of [Informative 1].

4 The string shall be left justified. Unused bytes shall be set to 'FF'.

5

5.2.33 EF_{USGIND} (UIM_ID/SF_EUIMID Usage Indicator)

This EF indicates whether the 32 bits of the UIM_ID or ESN_ME is used as the “ESN” value for CAVE authentication and MS identification, as per Section 4.6.1. This EF also indicates whether the 56-bits of the SF_EUIMID or MEID shall be used as the “MEID” field over the air when Service n34 is available. This indicator shall be set to comply with US Code of Federal Regulations 47 (CFR) 1998 Part 22.919, where applicable.

Identifier: ‘6F42’		Structure: transparent		Mandatory	
File size: 1 byte			Update activity: low		
Access Conditions:					
READ		PIN			
UPDATE		ADM			
INVALIDATE		ADM			
REHABILITATE		ADM			
Bytes	Description			M/O	Length
1	UIM ID/SF_EUIMID Usage Indicator			M	1 byte

Coding:

- 1 bit is used as the UIM ID usage indicator.
- first bit = 0: ESN_ME is used for CAVE authentication and MS identification.
- first bit = 1: UIM_ID is used for CAVE authentication and MS identification.
- 1 bit is used as the SF_EUIMID usage indicator.
- second bit = 0: MEID is used for MS identification.
- second bit = 1: SF_EUIMID is used for MS identification

Byte 1:

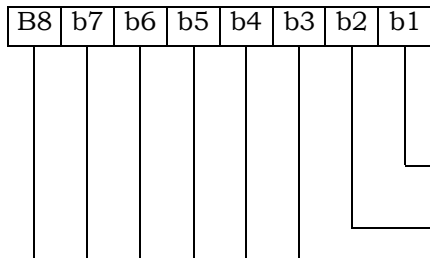

- b1=0: ESN_ME is used for CAVE Authentication and MS Identification.
- b1=1: UIM_ID is used for CAVE Authentication and MS Identification.
- b2=0: MEID is used for MS Identification.
- b2=1: SF_EUIMID is used for MS Identification.
- RFU

The default value for b1 shall be set to ‘0’.

If service n34 is not available, the b2 bit shall be set to ‘0’ and shall not be interpreted by the ME.

If service n34 is available and activated and the ME is assigned with ESN, then the b2 shall not be interpreted

1 5.2.34 EF_{AD} (Administrative Data)

2 This EF contains information concerning the mode of operation according to the type of UIM. It
 3 also provides an indication whether some ME features should be activated during the normal
 4 operation.

5

Identifier: '6F43'		Structure: transparent		Mandatory	
SFI: '01'					
File size: 3+X bytes			Update activity: low		
Access Conditions:					
READ		ALW			
UPDATE		ADM			
INVALIDATE		ADM			
REHABILITATE		ADM			
Bytes	Description	M/O	Length		
1	MS operation mode	M	1 byte		
2 – 3	Additional information	M	2 bytes		
4 – 3+X	RFU	O	X bytes		

6

7

- 8 - MS operation mode

9 Contents:

10 mode of operation for the MS.

11

12 Coding:

13 Initial value

- 14 - normal operation '00'.

15

16 Refer to [17] for other operational values.

17

18 Byte 1:

19

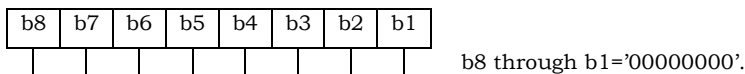

20

21

- 22 - Additional information

23 Coding:

- 24 - specific facilities (if b1=1 in byte 1);

25

26 Byte 2: (first byte of additional information)

27

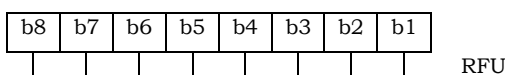

28

1
2
3
4

Byte 3:

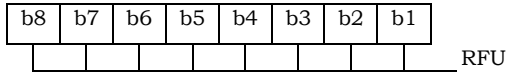

1 5.2.35 EF_{MDN} (Mobile Directory Number)

2 This EF stores the Mobile Directory Number, Type of Number, Numbering Plan, Presentation
3 Indicator and Screening Indicator.

4

Identifier: '6F44'		Structure: linear fixed		Optional	
Record length: 11 bytes			Update activity: low		
Access Conditions:					
READ		PIN			
UPDATE		PIN			
INVALIDATE		ADM			
REHABILITATE		ADM			
Bytes	Description		M/O	Length	
1	RFU	Number of digits	M	1 byte	
2 – 9	MDN		M	8 bytes	
10	NUMBER_TYPE and NUMBER_PLAN		M	1 byte	
11	PI and SI		M	1 byte	

5

6 Coding:

6

7 Byte 1:

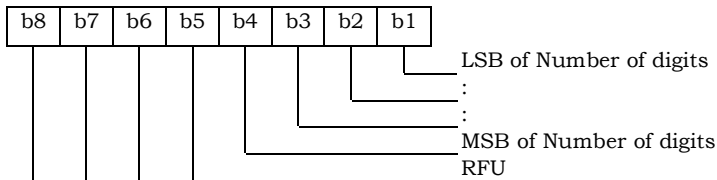

8

9 Byte 2 through 9 store MDN up to 15 digits described in Section 6.3.1.4 of [14]. Each digit shall
10 be encoded according to Table 6.7.1.3.2.4-4 of [14]. If MDN requires less than 15 digits, excess
11 nibbles at the end of data shall be set to 'F'.

12

13 Byte 2:

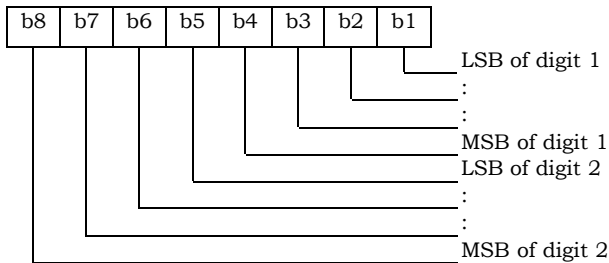

14

1

Byte 3:

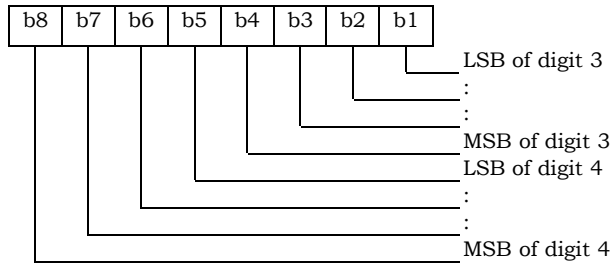

2

And Byte 4 through 9 shall follow the same format as Bytes 2 and 3.

3

4

5

Byte 10:

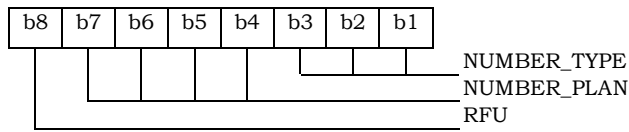

6

Refer to [14], Section 6.7.4.4.

7

8

Byte 11:

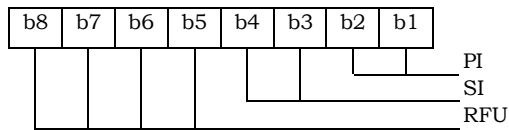

9

Refer to [14], Section 6.7.4.4.

1 5.2.36 EF_{MAXPRL} (Maximum PRL)

2 This EF stores the maximum size, in octets, that the CSIM can support for EF Preferred Roaming
 3 List and EF Extended Preferred Roaming List. See 3.5.3.1 and 3.5.3.3 of [7] for more detail.

4

Identifier: '6F45'		Structure: transparent		Mandatory	
File size: 2 or 4 bytes			Update activity: Never		
Access Conditions:					
READ		PIN			
UPDATE		ADM			
INVALIDATE		ADM			
REHABILITATE		ADM			
Bytes	Description		M/O	Length	
1 – 2	MAX_PR_LIST_SIZE for EF _{PRL}		M	2 bytes	
3 – 4	MAX_PR_LIST_SIZE for EF _{EPRL}		O	2 bytes	

5

1 5.2.37 EF_{SPCS} (SPC Status)

2 This EF identifies whether the EF_{SPC} (Service programming code) is set to default and internally
 3 updated in the card to reflect the current state of SPC after an OTASP commit if the SPC was
 4 changed. Details of SPC are in [7], Section 3.3.6.

5

Identifier: '6F46'		Structure: transparent		Mandatory	
File size: 1 byte			Update activity: low		
Access Conditions:					
READ		PIN			
UPDATE		NEVER			
INVALIDATE		NEVER			
REHABILITATE		NEVER			
Bytes	Description			M/O	Length
1	SPC Status			M	1 byte

6

7 - SPC Status

8

9 Coding:

10

11 Byte 1:

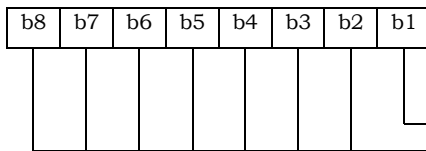

SPC Status
 b1=0: SPC is set to default value
 b1=1: SPC is set to any value other than the default value
 RFU

12

1 5.2.38 EF_{ECC} (Emergency Call Codes)

2 This EF contains up to 5 emergency call codes.

3

Identifier: '6F47'		Structure: transparent		Optional	
SFI: '09'					
File size: 3n (n ≤ 5) bytes			Update activity: low		
Access Conditions:					
READ		ALW			
UPDATE		ADM			
INVALIDATE		ADM			
REHABILITATE		ADM			
Bytes	Description			M/O	Length
1 - 3	Emergency Call Code 1			O	3 bytes
4 - 6	Emergency Call Code 2			O	3 bytes
(3n-2) to 3n	Emergency Call Code n			O	3 bytes

4

5 - Emergency Call Code

6 Contents:

7 Emergency Call Code. Each digit is encoded in BCD format.

8

9 Coding:

10 The emergency call code is of a variable length with a maximum length of 6 digits.
 11 Each emergency call code is coded on three bytes, with each digit within the code
 12 being coded on four bits as shown below. If a code of less than 6 digits is chosen, then
 13 the unused nibbles shall be set to 'F'.
 14

15 Byte 1:

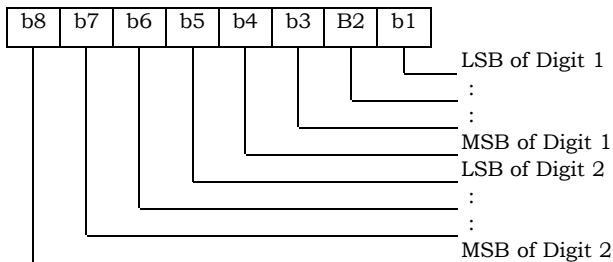

16

1

Byte 2:

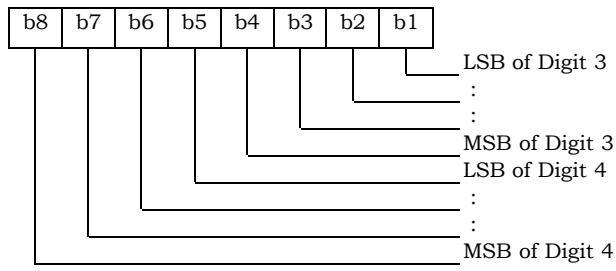

2

3

Byte 3:

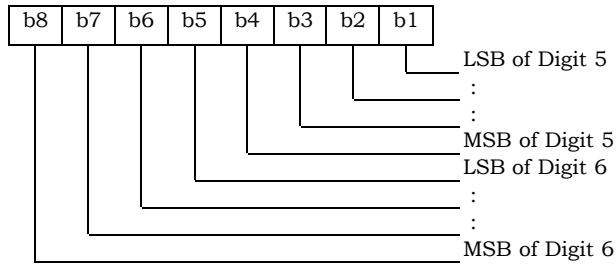

4

1 5.2.39 EF_{ME3GPDOPC} (ME 3GPD Operation Capability)

2 If either service n14 or n15 is available (see Section 5.2.18), this EF shall be present. This EF
 3 stores IP operation capabilities supported by the ME.

4

Identifier: '6F48'		Structure: transparent		Optional	
File size: 1 byte			Update activity: low		
Access Conditions:					
READ		PIN			
UPDATE		PIN			
INVALIDATE		ADM			
REHABILITATE		ADM			
Bytes	Description			M/O	Length
1	ME_3GPD_OP_MODE			M	1 byte

5

6 Coding:

7

Byte 1:

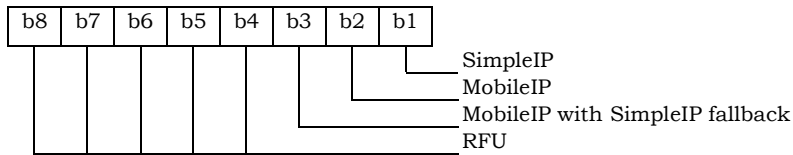

8

9 After the selection of ADF_{CSIM} during the initialization, the CSIM shall set the value of this byte to
 10 "0". An ME that supports Simple IP or Mobile IP shall set each subfield to '1' if it supports the
 11 corresponding operating mode.

12

1 5.2.40 EF_{3GPDOPM} (3GPD Operation Mode)

2 If either service n14 or n15 is available (see Section 5.2.18), this EF shall be present. This EF
 3 stores the 3GPD Operation Mode Parameter Block defined in [7].

4

Identifier: '6F49'		Structure: transparent		Optional	
File size: 1 byte			Update activity: low		
Access Conditions:					
READ		PIN			
UPDATE		PIN			
INVALIDATE		ADM			
REHABILITATE		ADM			
Bytes	Description			M/O	Length
1	See [7], 3GPD Operation Mode Parameter Block			M	1 byte

5

6 Coding:

7 Byte 1:



8

9

10

1 5.2.41 EF_{SIPCAP} (SimpleIP Capability Parameters)

2 If service n14 is available (see Section 5.2.18), this EF shall be present. This EF stores the
 3 SimpleIP Capability Parameter Block defined in [7].

4

Identifier: '6F4A'		Structure: transparent		Optional	
File size: 4 bytes			Update activity: low		
Access Conditions:					
READ		PIN			
UPDATE		ADM			
INVALIDATE		ADM			
REHABILITATE		ADM			
Bytes	Description			M/O	Length
1 – 4	See [7], SimpleIP Capability Parameter Block			M	4 bytes

5

6

1 5.2.42 EF_{MIPCAP} (MobileIP Capability Parameters)

2 If service n15 is available (see Section 5.2.18), this EF shall be present. This EF stores the
3 MobileIP Capability Parameter Block defined in [7].

4

Identifier: '6F4B'	Structure: transparent	Optional	
File size: 5 bytes	Update activity: low		
Access Conditions:			
READ	PIN		
UPDATE	ADM		
INVALIDATE	ADM		
REHABILITATE	ADM		
Bytes	Description	M/O	Length
1-5	See [7], MobileIP Capability Parameter Block	M	5 bytes

5

6

1 5.2.43 EF_{SIPUPP} (SimpleIP User Profile Parameters)

2 If service n14 is available (see Section 5.2.18), this EF shall be present. This EF stores the
 3 SimpleIP User Profile Parameter Block defined in [7].

4

Identifier: '6F4C'		Structure: transparent		Optional	
File size: 1+X			Update activity: low		
Access Conditions:					
READ		PIN			
UPDATE		ADM			
INVALIDATE		ADM			
REHABILITATE		ADM			
Bytes	Description			M/O	Length
1	Length of SimpleIP User Profile Parameter Block			M	1 byte
2 – X+1	See [7], SimpleIP User Profile Parameter Block			M	X bytes

5

6

1 5.2.44 EF_{MIPUPP} (MobileIP User Profile Parameters)

2 If service n15 is available (see Section 5.2.18), this EF shall be present. This EF stores the
 3 MobileIP User Profile Parameter Block defined in [7].

4

Identifier: '6F4D'		Structure: transparent		Optional	
File size: 1+X			Update activity: low		
Access Conditions:					
READ		PIN			
UPDATE		ADM			
INVALIDATE		ADM			
REHABILITATE		ADM			
Bytes	Description			M/O	Length
1	Length of MobileIP User Profile Parameter Block			M	1 byte
2 – X+1	See [7], MobileIP User Profile Parameter Block			M	X bytes

5

6

1 5.2.45 EF_{SIPSP} (SimpleIP Status Parameters)

2 If service n14 is available (see Section 5.2.18), this EF shall be present. This EF stores the
 3 SimpleIP Status Parameters Block defined in [7].

4

Identifier: '6F4E'		Structure: transparent		Optional	
File size: 1			Update activity: low		
Access Conditions:					
READ		PIN			
UPDATE		PIN			
INVALIDATE		ADM			
REHABILITATE		ADM			
Bytes	Description			M/O	Length
1	See [7], SimpleIP Status Parameters Block			M	1 byte

5

1 5.2.46 EF_{MIPSP} (MobileIP Status Parameters)

2 If service n15 is available (see Section 3.4.18), this EF shall be present. This EF stores the
 3 MobileIP Status Parameters Block defined in [7].

4

Identifier: '6F4F'		Structure: transparent		Optional	
File size: X			Update activity: low		
Access Conditions:					
READ		PIN			
UPDATE		PIN			
INVALIDATE		ADM			
REHABILITATE		ADM			
Bytes	Description			M/O	Length
1 – X	See [7], MobileIP Status Parameters Block			M	X bytes

5

1 5.2.47 EF_{SIPPAPSS} (SimpleIP PAP SS Parameters)

2 If service n14 is available (see Section 3.4.18), this EF shall be present. This EF stores the
 3 SimpleIP PAP SS Parameter Block defined in [7].

4

Identifier: '6F50'		Structure: transparent		Optional	
File size: 1+X			Update activity: low		
Access Conditions:					
READ		PIN			
UPDATE		PIN			
INVALIDATE		ADM			
REHABILITATE		ADM			
Bytes	Description	M/O	Length		
1	Length of SimpleIP PAP SS Parameter Block	M	1 byte		
2 – X+1	See [7], SimpleIP PAP SS Parameter Block	M	X bytes		

5

1 5.2.48 Reserved

2

1 5.2.49 Reserved

1 5.2.50 EF_{PUZL} (Preferred User Zone List)

2 This EF stores the Preferred User Zone List, as described in Section 3.5.7 of [7].

3

Identifier: '6F53'	Structure: transparent	Optional	
File size: 'CUR_UZ_LIST_SIZE'	Update activity: low		
Access Conditions:			
READ	PIN		
UPDATE	ADM		
INVALIDATE	ADM		
REHABILITATE	ADM		
Bytes	Description	M/O	Length
1- CUR_UZ_LIST_SIZ E	PUZL (see Section 3.5.6 of [7])	M	CUR_UZ_LIST_SI ZE

4

5

1 5.2.51 EF_{MAXPUZL} (Maximum PUZL)

2 This EF stores the maximum size, in octets, that the CSIM can support for EF_{PUZL} (See 3.5.7 of [7]
 3 for more detail) and the maximum number of User Zone entries that the CSIM can support for
 4 EF_{PUZL} (See 3.5.6.1. of [7] for more detail).

5

Identifier: '6F54'		Structure: transparent		Optional	
File size: 5 bytes			Update activity: Never		
Access Conditions:					
READ		PIN			
UPDATE		ADM			
INVALIDATE		ADM			
REHABILITATE		ADM			
Bytes	Description		M/O	Length	
1 -3	MAX_UZ_LIST_SIZE		M	3 bytes	
4 - 5	MAX_UZ		M	2 bytes	

6

7

5.2.52 EF_{MECRP} (ME-specific Configuration Request Parameters)

This EF stores ME-specific parameters to be used to form the response to the Configuration Request command while secure mode is active. The ME shall update these ME-specific parameters during initializations.

Identifier: '6F55'		Structure: transparent		Mandatory	
File size: 3 bytes			Update activity: low		
Access Conditions:					
READ		PIN			
UPDATE		PIN			
INVALIDATE		ADM			
REHABILITATE		ADM			
Bytes	Description			M/O	Length
1	SCM			M	1 byte
2	MOB_P_REV			M	1 byte
3	Local Control			M	1 byte

Coding:

Byte 1:

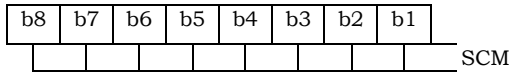

Note: b6 indicates if the ME is operating in slotted mode.

Byte 2:

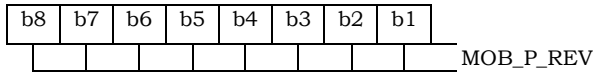

Byte 3:

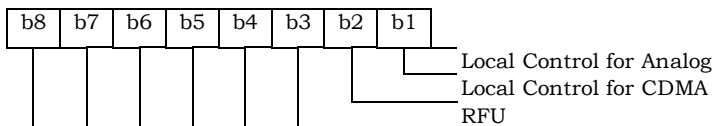

1 5.2.53 EF_{HRPDCAP} (HRPD Access Authentication Capability Parameters)

2 If service n8 is available (see Section 5.2.18), this EF shall be present. This EF stores the HRPD
 3 Access Authentication Capability Parameters Block defined in Section 3.5.8.12 of [7].

4

Identifier: '6F56'		Structure: transparent		Optional	
File size: 3 bytes			Update activity: low		
Access Conditions:					
READ		PIN			
UPDATE		ADM			
INVALIDATE		ADM			
REHABILITATE		ADM			
Bytes	Description			M/O	Length
1 – 3	See [7], HRPD Access Authentication Capability Parameters Block			M	3 bytes

5

6

1 5.2.54 EF_{HRPDUPP} (HRPD Access Authentication User Profile Parameters)

2 If service n8 is available (see Section 5.2.18), this EF shall be present. This EF stores the HRPD
3 Access Authentication User Profile Parameters Block defined in Section 3.5.8.13 of [7].

4

Identifier: '6F57'	Structure: transparent	Optional	
File size: 1+X bytes		Update activity: low	
Access Conditions:			
READ	PIN		
UPDATE	ADM		
INVALIDATE	ADM		
REHABILITATE	ADM		
Bytes	Description	M/O	Length
1	Length of HRPD Access Authentication User Profile Parameters Block	M	1 byte
2 – X+1	See [7], HRPD Access Authentication User Profile Parameters Block	M	X bytes

5

6

1 5.2.55 EF_{CSSPR} (CUR_SSPR_P_REV)

2 This EF stores the protocol revision of the current preferred roaming list stored in the EF_{EPRL}. This
 3 information is used by the ME to parse the EF_{EPRL}.

4

Identifier: '6F58'		Structure: transparent		Optional	
File size: 1			Update activity: low		
Access Conditions:					
READ		PIN			
UPDATE		ADM			
INVALIDATE		ADM			
REHABILITATE		ADM			
Bytes	Description			M/O	Length
1	CUR_SSPR_P_REV			M	1 byte

5

1 5.2.56 EF_{ATC} (Access Terminal Class)

2 If service n8 is available (see Section 5.2.18), this EF shall be present. This EF stores the class of
 3 access terminal used for Persistence Test in the system defined in [28].

4

Identifier: '6F59'		Structure: transparent		Optional	
File size: 1			Update activity: low		
Access Conditions:					
READ		PIN			
UPDATE		ADM			
INVALIDATE		ADM			
REHABILITATE		ADM			
Bytes	Description			M/O	Length
1	Access Terminal Class			M	1 byte

5

6 Coding:

7 Byte 1:

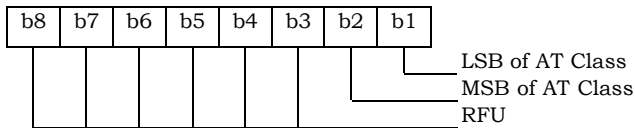

8

1 5.2.57 EF_{EPRL} (Extended Preferred Roaming List)

2 This EF stores the Extended Preferred Roaming List, as described in Section 3.5.3 of [7]. The
 3 Preferred Roaming List includes selection parameters from [5] and [14], Annex F.

4

Identifier: '6F5A'	Structure: transparent	Optional	
SFI: 'OE'			
File size: 'MAX_PR_LIST_SIZE'	Update activity: low		
Access Conditions:			
READ	PIN		
UPDATE	ADM		
INVALIDATE	ADM		
REHABILITATE	ADM		
Bytes	Description	M/O	Length
1-PR_LIST_SIZE	PR_LIST (see Section 3.5.5 of [7])	M	PR_LIST_SIZE

5

6

1 5.2.58 EF_{BCSMSefg} (Broadcast Short Message Configuration)

2 If service n9 is available, this EF shall be present.

3 This EF contains the operator broadcast configuration setting for Broadcast SMS. This
 4 information, determined by the operator, defines the filtering criteria that can be used by the ME
 5 to receive Broadcast SMS.

6

Identifier: '6F5B'		Structure: transparent		Optional	
File size: 1 byte			Update activity: low		
Access Conditions:					
READ		PIN			
UPDATE		ADM			
INVALIDATE		ADM			
REHABILITATE		ADM			
Bytes	Description			M/O	Length
1	Operator Broadcast Configuration			M	1 byte

7

8 Coding:

9 Byte 1:

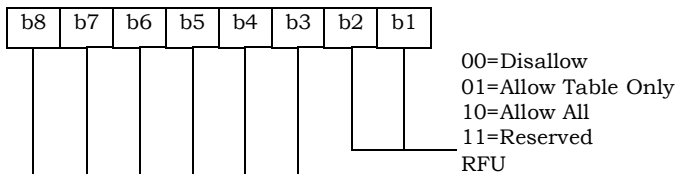

10

11

12 Operator configuration includes filtering criteria imposed by a service provider.

Field Name	Description
Disallow	This setting disables the mobile station's broadcast SMS capability (i.e., the mobile station will not process broadcast SMS).
Allow Table Only	This setting allows the mobile station to receive only broadcast messages for the service categories that have been programmed in EF _{BCSMStable}
Allow All	This setting allows the mobile station to receive broadcast messages for all service categories.

13

14

1 5.2.59 EF_{BCSMSpref} (Broadcast Short Message Preference)

2 If service n9 is available, this EF shall be present.

3 This EF contains the user broadcast configuration setting for Broadcast SMS. This information,
 4 determined by the user, defines the filtering criteria that can be used by the Mobile Equipment
 5 (ME) to receive Broadcast SMS.

6

Identifier: '6F5C'		Structure: transparent		Optional	
File size: 1 byte			Update activity: high		
Access Conditions:					
READ		PIN			
UPDATE		PIN			
INVALIDATE		ADM			
REHABILITATE		ADM			
Bytes	Description			M/O	Length
1	User Broadcast Configuration			M	1 byte

7

8 Coding:

9 Byte 1:

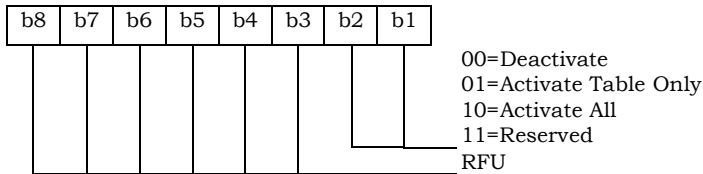

10

11 User configuration includes filtering criteria determined by the mobile user.

Field Name	Description
Deactivate	This setting deactivates the mobile station's broadcast SMS functions (i.e., the mobile station will not process broadcast SMS).
Activate Table Only	This setting allows the mobile station to receive only broadcast messages for the service categories that have been programmed in EFBCSMStable, subject to any additional filtering criteria included in EFBCSMStable based on user preferences. This setting is only valid if the operator configuration is not Disallow. Moreover, the mobile user can selectively enable and disable individual programmed entries in EFBCSMStable.
Activate All	This setting allows the mobile station to receive broadcast messages for all service categories. This setting is only valid if the operator configuration is "Allow All". EFBCSMStable will not be consulted for this setting.

12

13

5.2.60 EF_{BCSMStable} (Broadcast Short Message Table)

If service n9 is available, this EF shall be present.

This EF contains information in accordance with [8] comprising service category program parameters, which can be used by the Mobile Equipment (ME) for Broadcast SMS filtering. See Section 4.5.19 of [8] for more detail.

Each record in this EF is linked to a record with the same record index in EF_{BCSMSP}.

Identifier: '6F5D'		Structure: linear fixed		Optional	
Record Length: 7+X byte			Update activity: high		
Access Conditions:					
READ		PIN			
UPDATE		ADM			
INVALIDATE		ADM			
REHABILITATE		ADM			
Bytes	Description	M/O	Length		
1	Status	M	1 byte		
2 – 3	Service Category	M	2 bytes		
4	Language	M	1 byte		
5	Max Messages	M	1 byte		
6	Alert Option	M	1 byte		
7	Label Encoding	M	1 byte		
8 to 7+X	Label	M	X byte		

- Status

Contents:

Status byte of the record which can be used as a pattern in the SEEK command.

Coding:

Byte 1:

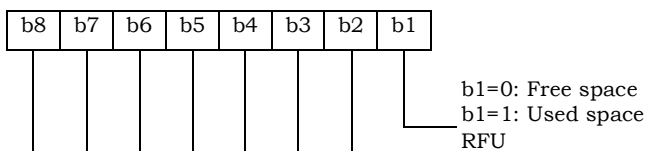

1
2
3
4
5
6
7
8
9
10
11
12
13

Byte 2:

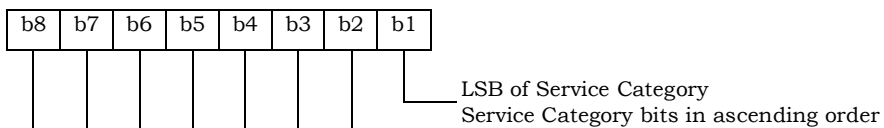

Byte 3:

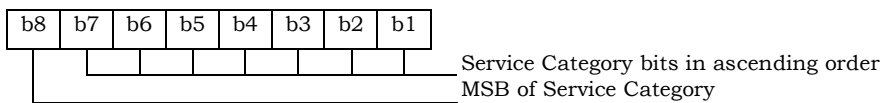

Byte 4:

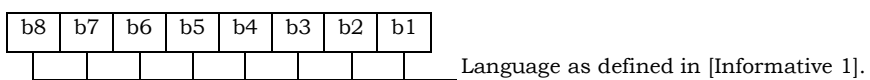

Byte 5:

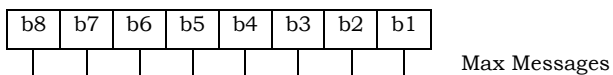

Byte 6:

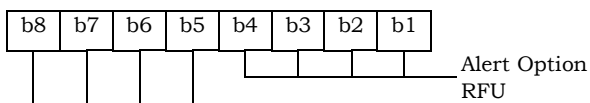

Byte 7:

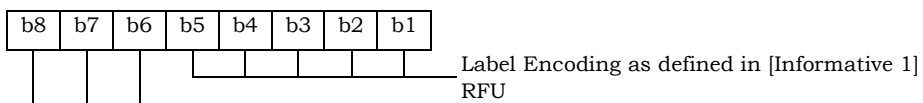

5.2.61 EF_{BCSMSP} (Broadcast Short Message Parameter)

If service n9 is available, this EF shall be present.

This EF contains selection flag and priority associated with service categories and used by the ME for filtering of BC-SMS. Each record in this EF is linked to a record with the same record index in EF_{BCSMStable}.

Identifier: '6F5E'		Structure: linear fixed		Optional	
Record Length: 2 bytes			Update activity: high		
Access Conditions:					
READ		PIN			
UPDATE		PIN			
INVALIDATE		ADM			
REHABILITATE		ADM			
Bytes	Description			M/O	Length
1	Select			M	1 byte
2	Priority			M	1 byte

Coding:

Byte 1:

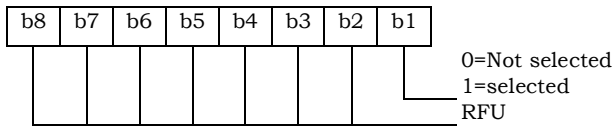

Byte 2:

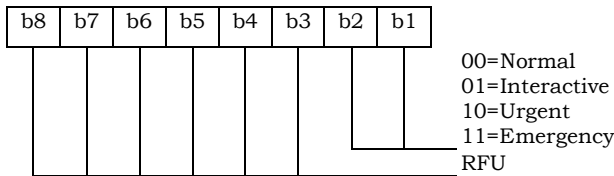

Unused records are filled with 'FF'. When the b1 of Byte 1 is set to '1', then the ME shall filter the BC-SMS according to the priority indicated in Byte 2.

5.2.62 EF_{BAKPARA} (Currently used BAK Parameters)

If service n18 is available, this EF shall be present.

This EF contains BCMCS related parameters, i.e.: BCMCS_Flow_ID, BAK_ID and BAK_Expire, corresponding to BAK keys that have been delivered to the CSIM and are currently used. See [36] for more details.

Identifier: '6F63'		Structure: Linear Fixed		Optional	
Record length: X+Y+Z+3 bytes			Update activity: high		
Access Conditions:					
READ		PIN			
UPDATE		ADM			
DEACTIVATE		ADM			
ACTIVATE		ADM			
Bytes	Description	M/O	Length		
1	Length of BCMCS_Flow_ID	M	1 byte		
2 to X +1	BCMCS_Flow_ID	M	X bytes		
X+2	Length of BAK_ID	M	1 byte		
X+3 to X+Y+2	BAK_ID	M	Y bytes		
X+Y+3	Length of BAK_Expire	M	1 byte		
X+Y+4 to X+Y+Z+3	BAK_Expire	M	Z bytes		

- Length of BCMCS_Flow_ID

Content: number of bytes of the following data item containing the BCMCS flow identifier.

Coding: Binary.

- BCMCS_Flow_ID

Content: BCMCS Flow Identifier

Coding: Binary.

- Length of BAK_ID

Content: number of bytes of the following data item containing the BAK identifier.

Coding: Binary

- BAK_ID

Content: BAK Identifier

1 Coding: Binary.

2

3 - Length of BAK_Expire

4 Content: number of bytes of the following data item containing the BAK_Expire.

5 Coding: Binary

6

7 - BAK_Expire

8 Content: BAK_Expire

9 Coding: Binary.

5.2.63 EF_{UpBAKPARA} (Updated BAK Parameters)

If service n18 is available, this EF shall be present.

This EF contains BCMCS related parameters, i.e.: BCMCS_Flow_ID, BAK_ID and BAK_Expire, corresponding to BAK keys that have been delivered to the CSIM but have not yet been used. See [36] for more details.

Identifier: '6F64'		Structure: cyclic		Optional
Record length: X+Y+Z+3 bytes			Update activity: high	
Access Conditions:				
READ		PIN		
UPDATE		ADM		
DEACTIVATE		ADM		
ACTIVATE		ADM		
Bytes	Description	M/O	Length	
1	Length of BCMCS_Flow_ID	M	1 byte	
2 to X +1	BCMCS_Flow_ID	M	X bytes	
X+2	Length of BAK_ID	M	1 byte	
X+3 to X+2+Y	BAK_ID	M	Y bytes	
X+Y+3	Length of BAK_Expire	M	1 byte	
X+Y+4 to X+Y+Z+3	BAK_Expire	M	Z bytes	

- Length of BCMCS_Flow_ID

Content: number of bytes of the following data item containing the BCMCS flow identifier.

Coding: Binary

- BCMCS_Flow_ID

Content: BCMCS Flow Identifier

Coding: Binary.

- Length of BAK_ID

Content: number of bytes of the following data item containing the BAK identifier.

Coding: Binary

- BAK_ID

Content: BAK Identifier

- 1 Coding: Binary.
- 2
- 3 - Length of BAK_Expire
- 4 Content: number of bytes of the following data item containing the BAK_Expire.
- 5 Coding: Binary
- 6
- 7 - BAK_Expire
- 8 Content: BAK_Expire
- 9 Coding: Binary.

1 5.2.64 EF_{MMSN} (MMS Notification)

2 If service n19 is available, this file shall be present.

3 This EF contains information in accordance with [37] comprising MMS notifications (and
4 associated parameters) which have been received by the ME from the network.

5

Identifier: '6F65'		Structure: Linear fixed		Optional	
Record length: 4+X bytes			Update activity: low		
Access Conditions:					
READ		PIN			
UPDATE		PIN			
INVALIDATE		ADM			
REHABILITATE		ADM			
Bytes	Description	M/O	Length		
1 - 2	MMS Status	M	2 bytes		
3	MMS Implementation	M	1 byte		
4 to X+3	MMS Notification	M	X bytes		
X+4	Extension file record number	M	1 byte		

6

7 - MMS Status

8

9 Content:

10 The status bytes contain the status information of the notification.

11

12 Coding:

13

- 14 - b1 indicates whether there is valid data or if the location is free.
- 15 - b2 indicates whether the MMS notification has been read or not.
- 16 - b3 and b4 of the first byte indicate the MM retrieval, MM rejection, or MM forwarding status.
- 17 - b5 to b8 of the first byte and the entire second byte are reserved for future use.

18

1
2
3
4
5
6
7
8
9
10
11
12
13
14
15
16
17
18
19
20
21
22
23
24
25
26

First byte:

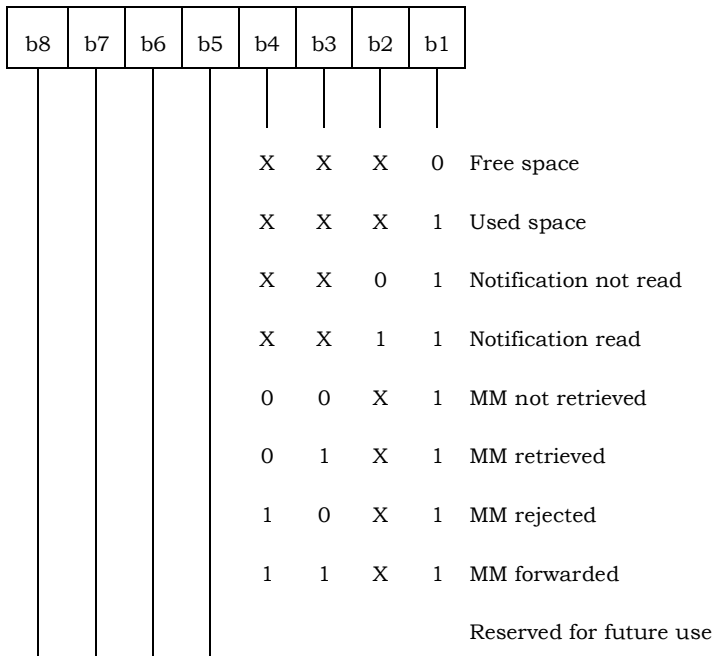

Second byte:

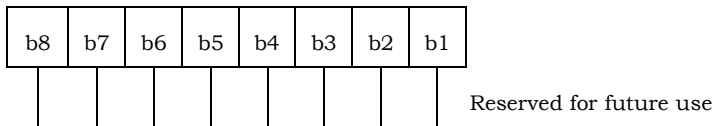

- MMS Implementation

Contents:

The MMS Implementation indicates the used implementation type, e.g. WAP, M-IMAP, SIP.

Coding:

Allocation of bits:

- Bit number Parameter indicated
 - 1 WAP implementation of MMS
 - 2 M-IMAP implementation of MMS
 - 3 SIP implementation of MMS
 - 4-8 Reserved for future use
- Bit value Meaning
 - 0 Implementation not supported.
 - 1 Implementation supported.

- MMS Notification

Contents:

The MMS Notification contains the MMS notification.

Coding:

- 1 The MMS Notification is coded according to the MMS Implementation as indicated in Byte 3.
- 2 Any unused byte shall be set to 'FF'.
- 3
- 4 - Extension file record number
- 5 Contents:
- 6 - extension file record number. This byte identifies the number of a record in the EF_{EXT8}
- 7 containing extension data for the notification information. The use of this byte is optional. If
- 8 it is not used it shall be set to 'FF'.
- 9 Coding:
- 10 - binary.
- 11

1 5.2.65 EF_{EXT8} (Extension 8)

2 If service n20 is available, this file shall be present.

3 This EF contains extension data of a MMS Notification (Multimedia Messaging Service).

4

Identifier: '6F66'		Structure: linear fixed		Optional	
Record length: X+2 bytes			Update activity: low		
Access Conditions:					
READ		PIN			
UPDATE		PIN			
INVALIDATE		ADM			
REHABILITATE		ADM			
Bytes	Description	M/O	Length		
1	Record type	M	1 byte		
2 to X+1	Extension data	M	X bytes		
X+2	Identifier	M	1 byte		

5

6 For contents and coding see [30].

1 5.2.66 EF_{MMSICP} (MMS Issuer Connectivity Parameters)

2 If service n19 is available, this file shall be present.

3 This EF contains values for Multimedia Messaging Connectivity Parameters as determined by the
 4 issuer, which can be used by the ME for MMS network connection. This file may contain one or
 5 more sets of Multimedia Messaging Issuer Connectivity Parameters. The first set of Multimedia
 6 Messaging Issuer Connectivity Parameters is used as the default set.

7 Each set of Multimedia Messaging Issuer Connectivity Parameters may consist of one or more
 8 "Interface to Core Network and Bearer information" TLV objects (only for WAP), but shall contain
 9 only one "MMS Implementation" TLV object (for WAP, M-IMAP and SIP), one "MMS Relay/Server"
 10 TLV object (for WAP, M-IMAP and SIP) and one "Gateway" TLV object (only for WAP).

11 The order of the "Interface to Core Network and Bearer information" TLV objects in the MMS
 12 Connectivity TLV object defines the priority of the Interface to Core Network and Bearer
 13 information, with the first TLV object having the highest priority.

14

Identifier: '6F67'		Structure: Transparent		Optional	
File Size: X ₁ +...+ X _n bytes			Update activity: low		
Access Conditions:					
READ		PIN			
UPDATE		ADM			
INVALIDATE		ADM			
REHABILITATE		ADM			
Bytes	Description			M/O	Length
1 to X ₁	MMS Connectivity Parameters TLV object			M	X ₁ bytes
X ₁ +1 to X ₁ + X ₂	MMS Connectivity Parameters TLV object			O	X ₂ bytes
...	...				
X ₁ +...+ X _{n-1} +1 to X ₁ +...+ X _n	MMS Connectivity Parameters TLV object			O	X _n bytes

15

16

1 - MMS Connectivity Parameters tags

Description	Tag Value
MMS Connectivity Parameters Tag	'AB'
MMS Implementation Tag	'80'
MMS Relay/Server Tag	'81'
Interface to Core Network and Bearer Information Tag	'82'
Gateway Tag	'83'
MMS Authentication Mechanism Tag	'84'
MMS Authentication ID Tag	'85'

2

1 - MMS Connectivity Parameters contents

Description	Value	M/O	Length (bytes)
MMS Connectivity Parameters Tag	'AB'	M	1
Length	Note 1	M	Note 2
MMS Implementation Tag	'80'	M	1
Length	1	M	1
MMS Implementation Information	--	M	1
MMS Relay/Server Tag	'81'	M	1
Length	X	M	Note 2
MMS Relay/Server Address	--	M	X
1 st Interface to Core Network and Bearer Information Tag (highest priority)	'82'	C2	1
Length	Y1	C2	Note 2
1 st Interface to Core Network and Bearer information	--	C2	Y1
2 nd Interface to Core Network and Bearer Information Tag	'82'	C2	1
Length	Y2	C2	Note 2
2 nd Interface to Core Network and Bearer information	--	C2	Y2
...			
N th Interface to Core Network and Bearer Information Tag (lowest priority)	'82'	C2	1
Length	Y3	C2	Note 2
N th Interface to Core Network and Bearer information	--	C2	Y3
Gateway Tag	'83'	O	1
Length	Z	O	Note 2
Gateway Information	--	O	Z
MMS Authentication Mechanism Tag	'84'	C1	1
Length	X	C1	Note 2
MMS Authentication Mechanism	--	C1	X
MMS Authentication ID Tag	'85'	C1	1
Length	X	C1	Note 2
MMS Authentication ID (Login_ID)	--	C1	X
NOTE 1: This is the total size of the constructed TLV object.			
NOTE 2: The length is coded according to ISO/IEC 8825.			
C1: only present if M-IMAP or SIP indicated in tag 80			
C2: only present if WAP is indicated in tag 80			

2

3

4

- MMS Implementation Tag '80'
See [30] for contents and coding.

1
2 - MMS Relay/server Tag '81'

3 Contents:

4 The MMS relay/server contains the address of the associated MMS relay/server; In
5 addition, for M-IMAP and SIP, authentication mechanism and authentication ID (Login
6 ID) are also included.

7 Coding:

8 The MMS relay/server address is coded as URI appropriate to the MM1 implementation
9 being used, for example SIP, or M-IMAP.

10
11 - Interface to Core Network and Bearer Information Tag '82'

12 Contents:

13 The Interface to Core Network and Bearer Information may contain the following
14 information to set up the bearer: Bearer, Address, Type of address, Speed, Call type,
15 Authentication type, Authentication id, Authentication password.

16 Coding:

17 The coding is according to the guideline provided in [37]. If MMS implementation type is
18 WAP, all instances of Interface to Core Network and Bearer Information are optional. If
19 MMS implementation type is M-IMAP or SIP, no Interface to Core Network and Bearer
20 Information is needed.

21
22 - Gateway Tag '83'

23 Contents:

24 The Gateway may contain the following information; Address, Type of address, Port,
25 Service, Authentication type, Authentication id and Authentication password.

26 Coding:

27 The coding is according to the guideline provided in [37].

28
29 - MMS Authentication Mechanism Tag '84'

30 Contents:

31 The MMS authentication mechanism contains the authentication mechanism for MMS. It
32 is mandatory for M-IMAP and SIP.

33 Coding:

34 The MMS authentication mechanism is coded as in Section 4.10.1 of [46].

35
36 - MMS Authentication ID Tag '85'

37 Contents:

38 The MMS authentication ID contains the authentication ID for MMS. It is mandatory for
39 M-IMAP and SIP.

40 Coding:

41 The coding is according to the guideline provided in [37].

42
43 Unused bytes shall be set to 'FF'.
44

1 5.2.67 EF_{MMSUP} (MMS User Preferences)

2 If service n19 is available, this file shall be present.

3 This EF contains values for Multimedia Messaging Service User Preferences, which can be used by
 4 the ME for user assistance in preparation of mobile multimedia messages (e.g. default values for
 5 parameters that are often used).

6

Identifier: '6F68'	Structure: Linear Fixed	Optional	
Record Length: X bytes	Update activity: low		
Access Conditions:			
READ	PIN		
UPDATE	PIN		
INVALIDATE	ADM		
REHABILITATE	ADM		
Bytes	Description	M/O	Length
1 to X	MMS User Preference TLV Objects	M	X bytes

7

8 - MMS User Preference tags

Description	Tag Value
MMS Implementation Tag	'80'
MMS User preference profile name Tag	'81'
MMS User Preference information Tag	'82'

9

10 - MMS User Preference information

Description	Value	M/O	Length (bytes)
MMS Implementation Tag	'80'	M	1
Length	1	M	Note
MMS Implementation information	--	M	1
MMS User preference profile name Tag	'81'	M	1
Length	X	M	Note
MMS User profile name	--	M	X
MMS User Preference information Tag	'82'	M	1
Length	Y	M	Note
MMS User Preference information	--	M	Y
NOTE: The length is coded according to ISO/IEC 8825.			

11

- 1 - MMS Implementation Tag '80'
2 For contents and coding see [30].
3
4 - MMS User preference profile name Tag '81'
5 Contents:
6 Alpha tagging of the MMS user preference profile.
7 Coding:
8 This alpha-tagging shall use either:
9
 - 10 • the SMS default 7-bit coded alphabet as defined in [38] with bit 8 set to 0. The alpha
 - 11 • one of the UCS2 coded options as defined in the annex of [30].
12
13 - MMS User Preference information Tag '82'
14 Contents:
15 The following information elements may be coded; Sender Visibility, Delivery Report,
16 Read-Reply, Priority, Time of Expiry and Earliest Delivery Time. Refer to [37], [39], [40],
17 and [41].
18 Coding:
19 Depending upon the MMS implementation as indicated in Tag '80'.
20

1 5.2.68 EF_{MMSUCP} (MMS User Connectivity Parameters)

2 If service n19 and n21 are available, this file shall be present.

3 This EF contains values for Multimedia Messaging Connectivity Parameters as determined by the
 4 user, which can be used by the ME for MMS network connection. This file may contain one or
 5 more sets of Multimedia Messaging User Connectivity Parameters.

6 Each set of Multimedia Messaging User Connectivity Parameters may consist of one or more
 7 "Interface to Core Network and Bearer information" TLV objects (only for WAP), but shall contain
 8 only one "MMS Implementation" TLV object (for WAP, M-IMAP and SIP), one "MMS Relay/Server"
 9 TLV object (for WAP, M-IMAP and SIP) and one "Gateway" TLV object (only for WAP).

10 The order of the "Interface to Core Network and Bearer information" TLV objects in the MMS
 11 Connectivity TLV object defines the priority of the Interface to Core Network and Bearer
 12 information, with the first TLV object having the highest priority.

13

Identifier: '6F69'		Structure: Transparent		Optional	
File Size: $X_1 + \dots + X_n$ bytes			Update activity: low		
Access Conditions:					
READ		PIN			
UPDATE		PIN/PIN2 (fixed during administrative management)			
INVALIDATE		ADM			
REHABILITATE		ADM			
Bytes		Description		M/O	Length
1 to X_1		MMS Connectivity Parameters TLV object		O	X_1 bytes
X_1+1 to $X_1 + X_2$		MMS Connectivity Parameters TLV object		O	X_2 bytes
...		...			
$X_1 + \dots + X_{n-1} + 1$ to $X_1 + \dots + X_n$		MMS Connectivity Parameters TLV object		O	X_n bytes

14

15 For the contents and coding see Section 5.2.65 EF_{MMSICP}.

5.2.69 EF_{AuthCapability} (Authentication Capability)

If service n22 is available, this file shall be present. This EF stores authentication capabilities for each application supported by the CSIM.

Identifier: '6F6A'		Structure: Linear Fixed		Optional
Record Length: 5 bytes			Update activity: low	
Access Conditions:				
READ		PIN		
UPDATE		ADM		
INVALIDATE		ADM		
REHABILITATE		ADM		
Bytes	Description	M/O	Length	
1	Application ID	M	1 byte	
2-3	Authentication Capability	M	2 bytes	
4-5	Reserved	M	2 bytes	

Coding:

Byte 1:

The coding for Application ID is as follows:

Binary Value	Application ID
'00000000'	MMS
'0000001'-'11111111'	Reserved

Byte 2:

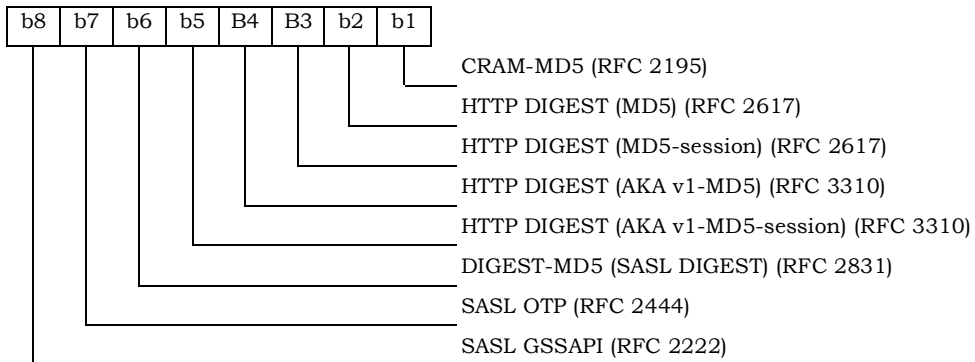

Bytes 3-5 are reserved.

1 The CSIM shall set each subfield to '1' if it supports the corresponding authentication
2 mechanism.

1 5.2.70 EF_{3GCIK} (3G Cipher and Integrity Keys)

2 If service n16 is available, this file shall be present.

3 This EF contains the cipher key (CK), the integrity key (IK).

4

Identifier : '6F6B'	Structure : transparent	Optional	
SFI: '0B'			
File size: 32 bytes	Update activity: low		
Access Conditions:			
READ	PIN		
UPDATE	ADM		
INVALIDATE	ADM		
REHABILITATE	ADM		
Bytes	Description	M/O	Length
1 - 16	Cipher key CK	M	16 bytes
17 - 32	Integrity key IK	M	16 bytes

- 5
- 6 - Cipher key CK.

7 Coding:

8 The least significant bit of CK is the least significant bit of the 16th byte. The most
9 significant bit of CK is the most significant bit of the 1st byte.

- 10
- 11 - Integrity key IK.

12 Coding:

13 The least significant bit of IK is the least significant bit of the 32nd byte. The most
14 significant bit of IK is the most significant bit of the 17th byte.

1 5.2.71 EF_{DCK} (De-Personalization Control Keys)

2 If service n25 is available, this EF shall be present.

3 This EF provides storage for the de-personalization control keys associated with the OTA
 4 de-personalization cycle of [44].

5

Identifier: '6F6C'		Structure: transparent		Optional	
File size: 20 bytes			Update activity: low		
Access Conditions:					
READ		PIN			
UPDATE		PIN			
INVALIDATE		ADM			
REHABILITATE		ADM			
Bytes	Description			M/O	Length
1 to 4	8 digits of Network Type 1 de-personalization control key			M	4 bytes
5 to 8	8 digits of Network Type 2 de-personalization control key			M	4 bytes
9 to 12	8 digits of service provider de-personalization control key			M	4 bytes
13 to 16	8 digits of corporate de-personalization control key			M	4 bytes
17 to 20	8 digits of HRPD Network de-personalization control key			M	4 bytes

6 Empty control key fields shall be coded 'FFFFFFFF'.

7

1 5.2.72 EF_{GID1} (Group Identifier Level 1)

2 If service n23 is available, this EF shall be present.

3 This EF contains identifiers for particular CSIM/ME associations. It can be used to identify a
4 group of CSIMs for a particular application.

5

Identifier: '6F6D'		Structure: transparent		Optional	
File size: 1 to n bytes			Update activity: low		
Access Conditions:					
READ		PIN			
UPDATE		ADM			
INVALIDATE		ADM			
REHABILITATE		ADM			
Bytes	Description			M/ O	Length
1 to n	CSIM group identifier(s)			O	n bytes

6

7

1 5.2.73 EF_{GID2} (Group Identifier Level 2)

2 If service n24 is available, this EF shall be present.

3 This EF contains identifiers for particular CSIM/ME associations. It can be used to identify a
 4 group of CSIMs for a particular application.

5

Identifier: '6F6E'		Structure: transparent		Optional	
File size: 1 to n bytes			Update activity: low		
Access Conditions:					
READ		PIN			
UPDATE		ADM			
INVALIDATE		ADM			
REHABILITATE		ADM			
Bytes	Description			M/ O	Length
1 to n	CSIM group identifier(s)			O	n bytes

6

7 NOTE: The structure of EF_{GID1} and EF_{GID2} are identical. They are provided to allow the
 8 network operator to enforce different levels of security dependant on an application.

9

10

5.2.74 EF_{CDMACNL} (CDMA Co-operative Network List)

If service n26 is available, this EF shall be present.

This EF contains the Co-operative Network List for the multiple network personalization services defined in [44].

Identifier: '6F6F'		Structure: transparent		Optional	
File size: 7n bytes			Update activity: low		
Access Conditions:					
READ		PIN			
UPDATE		ADM			
INVALIDATE		ADM			
REHABILITATE		ADM			
Bytes	Description			M/O	Length
1 to 7	Element 1 of co-operative net list			M	7 bytes
...					
7n-6 to 7n	Element n of co-operative net list			O	7 bytes

- Co-operative Network List

Contents:

Service provider ID and corporate ID of co-operative networks.

Coding:

For each 7 byte list element:

Byte 1 to 3: MCC + MNC: As per ITU-T Recommendation E.212 Annex A.

Byte 4 to 5: 4 most significant digits of the International Roaming based MIN.

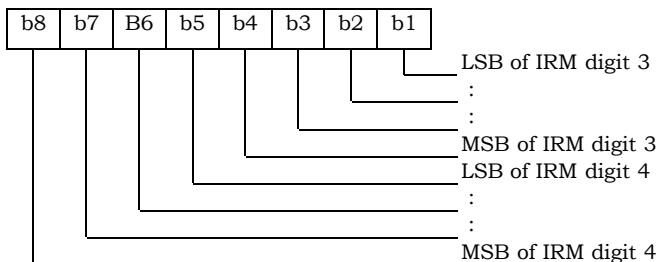
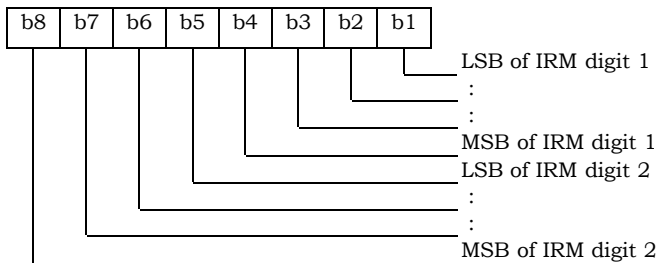

1

2

Byte 6:

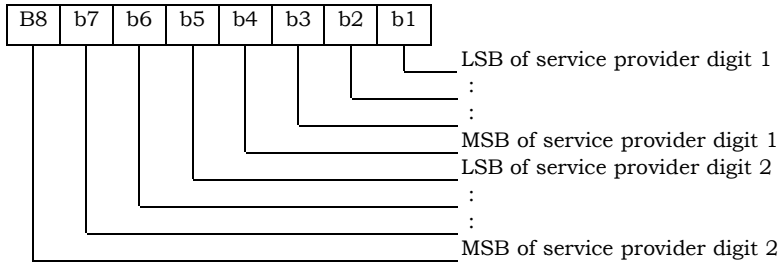

3

4

5

Byte 7:

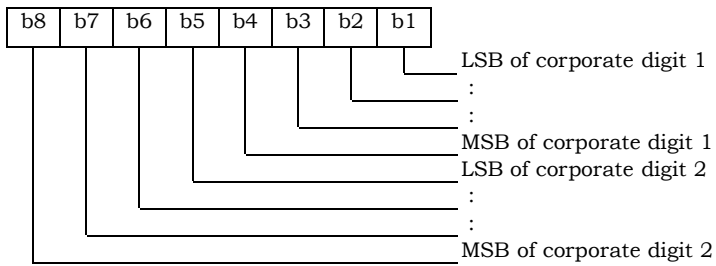

6

7

Empty fields shall be coded with 'FF'.

8

The end of the list is delimited by the first MCC field coded 'FFF'.

1 5.2.75 EF_{HOME_TAG} (Home System Tag)

2 This EF stores the Home System Tag, as described in Section 3.5.10.1 of [7].

3

Identifier: '6F70'		Structure: transparent		Mandatory	
File size: X bytes			Update activity: low		
Access Conditions:					
READ		PIN			
UPDATE		ADM			
INVALIDATE		ADM			
REHABILITATE		ADM			
Bytes	Description			M/O	Length
1 - X	Home System Tag (see Section 3.5.10.1 of [7])			M	Variable

4

5

1 5.2.76 EF_{GROUP_TAG} (Group Tag List)

2 This EF stores the Group Tag List, as described in Section 3.5.11 of [7].

3

Identifier: '6F71'		Structure: transparent		Mandatory	
File size: GROUP_TAG_LIST_SIZE			Update activity: low		
Access Conditions:					
READ		PIN			
UPDATE		ADM			
INVALIDATE		ADM			
REHABILITATE		ADM			
Bytes	Description	M/O	Length		
1- GROUP_T AG_LIST_ SIZE	Group Tag List (see Section 3.5.11 of [7])	M	Variable		

4

5

1 5.2.77 EF_{SPECIFIC_TAG} (Specific Tag List)

2 This EF stores the Specific Tag List, as described in Section 3.5.11 of [7].

3

Identifier: '6F72'		Structure: transparent		Mandatory	
File size: SPEC_TAG_LIST_SIZE'			Update activity: low		
Access Conditions:					
READ		PIN			
UPDATE		ADM			
INVALIDATE		ADM			
REHABILITATE		ADM			
Bytes	Description		M/O	Length	
1- SPEC_TA G_LIST_SI ZE	Specific Tag List (see Section 3.5.11 of [7])		M	Variable	

4

1 5.2.78 EF_{CALL_PROMPT} (Call Prompt List)

2 This EF stores the Call Prompt List, as described in Section 3.5.11 of [7].

3

Identifier: '6F73'		Structure: transparent		Mandatory
File size: 'CALL_PRMPPT_LIST_SIZE'			Update activity: low	
Access Conditions:				
READ		PIN		
UPDATE		ADM		
INVALIDATE		ADM		
REHABILITATE		ADM		
Bytes	Description	M/O	Length	
1- CALL_PR MPT_LIST _SIZE	Call Prompt List (see Section 3.5.11 of [7])	M	Variable	

4

1 5.2.79 EF_{SF_EUIMID} (Short Form EUIMID)

2 If service n34 is available, this file shall be present.

3 This EF stores the 56-bit electronic identification number (ID) unique to the CSIM.

4 The order of the digits when treated as 14 four-bit digits is shown in the table below, with 'd1'
5 representing the leftmost/most significant digit and 'd14' representing the rightmost/least
6 significant digit.

Identifier: '6F74'		Structure: transparent				Optional				
File size: 7 bytes				Update activity: low						
Access Conditions:										
READ		ALW								
UPDATE		Never								
INVALIDATE		Never								
REHABILITATE		Never								
Description										
Bytes	8	7	6	5	4	3	2	1	M/O	Length
1	d13				d14				M	1 byte
2	d11				d12				M	1 byte
3	d9				d10				M	1 byte
4	d7				d8				M	1 byte
5	d5				d6				M	1 byte
6	d3				d4				M	1 byte
7	d1				d2				M	1 byte

9

1 5.2.80 EF_{EST} (Enabled Service Table)

2 This EF indicates which services are enabled. If a service is not indicated as enabled in this table,
3 the ME shall not select the service.

4

Identifier: '6F75'		Structure: transparent		Optional	
SFI: '0F'					
File size: X bytes			Update activity: low		
Access Conditions:					
READ		PIN			
UPDATE		PIN2			
DEACTIVATE		ADM			
ACTIVATE		ADM			
Bytes	Description			M/O	Length
1	Services n° 1 to n° 8			M	1 byte
2	Services n° 9 to n° 16			O	1 byte
etc.					
X	Services n° (8X-7) to n° (8X)			O	1 byte

5 -Services

Service n°1: Fixed Dialling Numbers (FDN)

Contents:

6 The EF shall contain at least one byte. Further bytes may be included, but if the EF includes an
7 optional byte, then the EF shall also contain all bytes before that byte. Other services are possible in
8 the future. The coding falls under the responsibility of the 3GPP2.

9 Coding:

- 10 - 1 bit is used to code each service:
11 bit = 1: service activated;
12 bit = 0: service deactivated.
13 - Unused bits shall be set to '0'.

1 A service which is listed in this table is enabled if it is indicated as available in the CSIM Service
2 Table (CST) and indicated as activated in the Enabled Services Tables (EST) otherwise this service is,
3 either not available or disabled.

4

5 First byte:

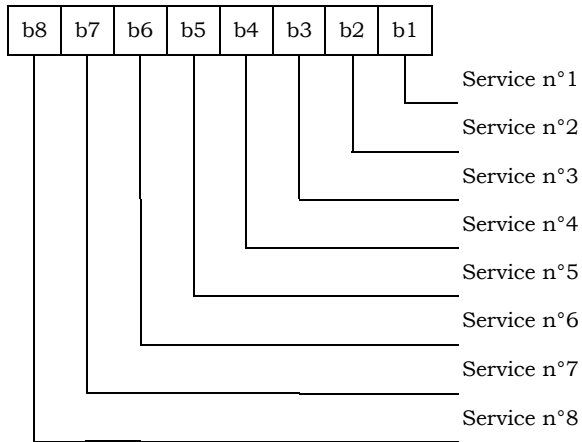

6

7 etc.

1 5.2.81 EF_{HiddenKey} (Key for hidden phone book entries)

2 This EF contains the hidden key that has to be verified by the ME in order to display the phone
 3 book entries that are marked as hidden. The hidden key can consist of 4 to 8 digits.

Identifier: '6F76'		Structure: transparent		Optional	
File size: 4 bytes			Update activity: low		
Access Conditions:					
READ		PIN			
UPDATE		PIN			
DEACTIVATE		ADM			
ACTIVATE		ADM			
Bytes	Description			M/O	Length
1 to 4	Hidden Key			M	4 bytes

4 - Hidden Key.

5 Coding:

6 - The hidden key is coded on 4 bytes using BCD coding. The minimum number of digits is 4.
 7 Unused digits are padded with 'F'.

8 • NOTE 1: Digits are not swapped, i.e. for instance the key "1234" is coded as '12 34 FF FF'.

9 • NOTE 2: The phone book entries marked as hidden are not scrambled by means of the
 10 hidden key. They are stored in plain text in the phone book.

5.2.82 EF_{LCSVER} (LCS Protocol Version)

If service n17 is available, this file shall be present.

This EF contains 'n' LCS Protocol Version Parameters (as defined in [50]) to indicate the version(s) of the supported protocol(s) supported by CSIM.

Each element of Protocol Version Parameter consists of 'S-SAFE Protocol version', 'TLS Session-A Protocol version', and 'TLS Session-B Protocol version'.

CSIM may support more than one version for each protocol.

Identifier: '6F77'		Structure: transparent		Optional	
File size: 4n bytes			Update activity: low		
Access Conditions:					
READ		PIN			
UPDATE		ADM			
DEACTIVATE		ADM			
ACTIVATE		ADM			
Bytes	Description			M/O	Length
1 to 4	1 st element of Protocol Version Parameter			M	4 bytes
...
4n-3 to 4n	n th element of Protocol Version Parameter			O	4 bytes

- Protocol Version Parameter

Contents:

S-SAFE Protocol version, TLS Session-A Protocol version, and TLS Session-B Protocol version.

Coding:

For each 4 bytes list element:

Byte 1: S-SAFE Protocol version (LCS_S_SAFE_VERSION).

Byte 2 to 3: TLS Session-A Protocol version (TLS client_version/server_version).

Byte 4: TLS Session-B Protocol version (LCS_UIM_PDE_TLS_PSK_VERSION).

Empty fields shall be coded with 'FF'.

1 5.2.83 EF_{LCS}CP (LCS Connectivity Parameter)

2 If service n17 is available, this file shall be present.

3 This EF contains values for IP-based LCS Connectivity Parameters as determined by the issuer,
4 which can be used by the ME for LCS network connection.

5

Identifier: '6F78'		Structure: Transparent		Optional	
File Size: X bytes			Update activity: low		
Access Conditions:					
READ		PIN			
UPDATE		ADM			
INVALIDATE		ADM			
REHABILITATE		ADM			
Bytes	Description			M/O	Length
1 to X	LCS TLS Connectivity Parameters TLV objects			M	X bytes

6

7 LCS TLS Connectivity Parameters tags

Description	Tag Value
H-PS address (IPv4) Tag	'80'
H-PS address (IPv6) Tag	'81'
H-PS address (URL) Tag	'82'

8

9 - LCS Connectivity Parameters contents

Description	Value	M/O	Length (bytes)
H-PS Address (IPv4) Tag	'80'	O	1
Length	6	O	1
H-PS IPv4 Address	--	O	4
H-PS IPv4 Port Number	--	O	2
H-PS Address (IPv6) Tag	'81'	O	1
Length	18	O	1
H-PS IPv6 Address	--	O	16
H-PS IPv6 Port Number	--	O	2
H-PS Address (URL) Tag	'82'	M	1
Length	X	M	1
H-PS URL Address	--	M	X

10

1 5.2.84 EF_{SDN} (Service Dialling Numbers)

2 This EF contains special service numbers (SDN) and/or the respective supplementary service
 3 control strings (SSC). In addition it contains identifiers of associated network/bearer capabilities
 4 and identifiers of extension records at the CSIM ADF level. It may also contain associated
 5 alpha-tagging.

6

Identifier: '6F79'		Structure: linear fixed		Optional	
Record length: X+14 bytes			Update activity: low		
Access Conditions:					
READ		PIN			
UPDATE		ADM			
DEACTIVATE		ADM			
ACTIVATE		ADM			
Bytes	Description	M/O	Length		
1-X	Alpha identifier	O	X bytes		
X+1	Length of BCD number/SSC contents	M	1 byte		
X+2	TON and NPI	M	1 byte		
X+3 to X+12	Dialling Number/SSC String	M	10 bytes		
X+13	Capability/Configuration2 (EF _{CCP2}) Record Identifier	M	1 byte		
X+14	Extension3 (EF _{EXT3}) Record Identifier	M	1 byte		

7
 8 For contents and coding of all data items see the respective data items of the EF_{ADN} (Section
 9 5.4.1), with the exception that extension records are stored in the EF_{EXT3} and
 10 capability/configuration parameters are stored in EF_{CCP2}.

11 NOTE: The value of X (the number of bytes in the alpha-identifier) may be different to the length
 12 denoted X in EF_{ADN}.

1 5.2.85 EF_{EXT2}(Extension2)

2 This EF contains extension data of an FDN (see FDN in 5.2.27).

3

Identifier: '6F7A'		Structure: linear fixed		Optional
Record length: 13 bytes			Update activity: low	
Access Conditions:				
READ PIN				
UPDATE PIN2				
DEACTIVATE ADM				
ACTIVATE ADM				
Bytes	Description	M/O	Length	
1	Record type	M	1 byte	
2 to 12	Extension data	M	11 bytes	
13	Identifier	M	1 byte	

4

5 For contents and coding see Section 5.4.2 (EF_{EXT1}).

6

1 5.2.86 EF_{EXT3}(Extension3)

2 This EF contains extension data of an SDN (see SDN in 5.2.81).

3

Identifier: '6F7B'		Structure: linear fixed		Optional	
Record length: 13 bytes			Update activity: low		
Access Conditions:					
READ		PIN			
UPDATE		ADM			
DEACTIVATE		ADM			
ACTIVATE		ADM			
Bytes	Description	M/O	Length		
1	Record type	M	1 byte		
2 to 12	Extension data	M	11 bytes		
13	Identifier	M	1 byte		

4

5 For contents and coding see Section 5.4.2 (EF_{EXT1}).

1 5.2.87 EF_{ICI} (Incoming Call Information)

2 If service n28 is "available", this file shall be present.

3 This EF is located within the CSIM application. The incoming call information can be linked to the
4 phone book stored under DF_{TELECOM} or to the local phone book within the CSIM. The EF_{ICI} contains
5 the information related to incoming calls.

6 The time of the call and duration of the call are stored in this EF. This EF can also contain
7 associated alpha identifier that may be supplied with the incoming call. In addition, it contains
8 identifiers of associated network/bearer capabilities and identifiers of extension records at the
9 CSIM ADF level. The structure of this EF is cyclic, so the contents shall be updated only after a
10 call is disconnected.

11 If Calling Line Identifier is supported and the incoming phone number matches a number stored
12 in the phone book the incoming call information is linked to the corresponding information in the
13 phone book. If the incoming call matches an entry but is indicated as hidden in the phone book
14 the link is established but the information is not displayed by the ME if the code for the secret
15 entry has not been verified. The ME shall not ask for the secret code to be entered at this point.

16 Optionally the ME may store the link to phone book entry in the file, so that it does not need to
17 look again for a match in the phone book when it reuses the entry. But the ME will have to check
18 that the incoming call number still exists in the linked phone book entry, as the link might be
19 broken (entry modified). When not used by the ME or no link to the phone book has been found,
20 this field shall be set to 'FFFFFF'.

21 The first byte of this link is used to identify clearly the phone book location either global (i.e. under
22 DF_{TELECOM}) or local (i.e. CSIM specific).

23 For the current version of the phone book, the phone book entry is identified as follows:

- 24 - the record number in the EF_{PBR} which indicates the EF_{ADN} containing the entry;
- 25 - the record number inside the indicated EF_{ADN}.

26 The structure of EF_{ICI} is shown below. Coding scheme is according to EF_{ADN}

Identifier: '6F7C'	Structure: Cyclic	Optional	
SFI: '10'			
Record length: X+28 bytes	Update activity: high		
Access Conditions:			
READ	PIN		
UPDATE	PIN		
DEACTIVATE	ADM		
ACTIVATE	ADM		
Bytes	Description	M/ O	Length
1 to X	Alpha Identifier	O	X bytes
X+1	Length of BCD number contents	M	1 byte
X+2	TON and NPI	M	1 byte
X+3 to X+12	Incoming Call Number	M	10 bytes
X+13	Capability/Configuration2 (EF _{CCP2}) Record Identifier	M	1 byte
X+14	Extension5 (EF _{EXT5}) Record Identifier	M	1 byte
X+15 to X+21	Incoming call date and time (see detail 1)	M	7 bytes
X+22 to X+24	Incoming call duration (see detail 2)	M	3 bytes
X+25	Incoming call status (see detail 3)	M	1 byte
X+26 to X+28	Link to phone book entry (see detail 4)	M	3 bytes

1

2 NOTE: When the contents except incoming call status are invalid, they are filled with 'FF'.

3 **Detail 1: Coding of date and time.**

4 Content:

5 the date and time are defined by the ME.

6 Coding:

7 it is according to the extended BCD coding from Byte1 to Byte 7. The first 3 bytes show year,
8 month and day (yy.mm.dd). The next 3 bytes show hour, minute and second (hh.mm.ss).
9 The last Byte 7 is Time Zone. The Time Zone indicates the difference, expressed in quarters
10 of an hour, between the local time and GMT. Bit 4 in Byte 7 represents the algebraic sign of
11 this difference (0: positive, 1: negative). If the terminal does not support the Time Zone, Byte
12 7 shall be "FF". Byte X+15: Year.

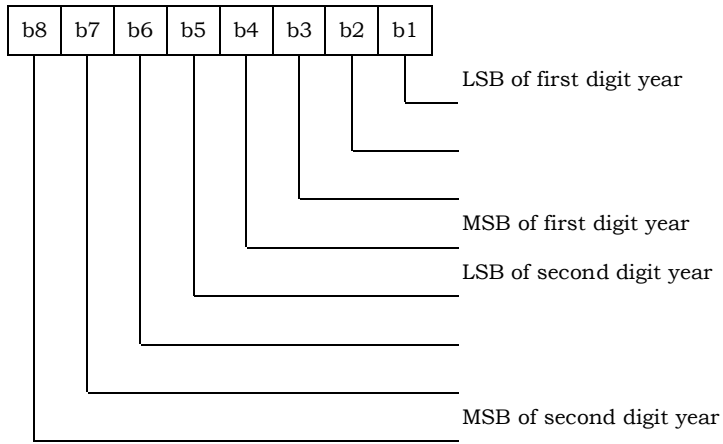

1

2 Byte X+16: Month

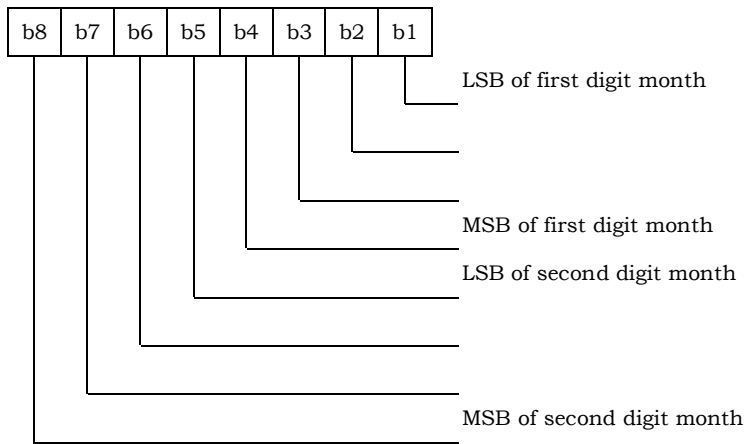

3

4 Byte X+17: Day

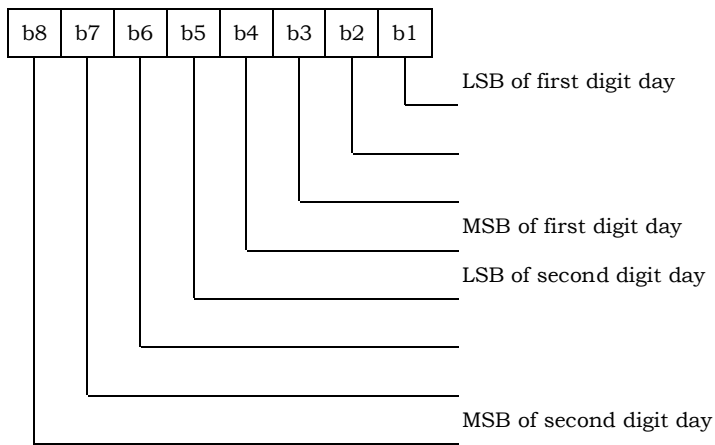

5

1 Byte X+18: Hour

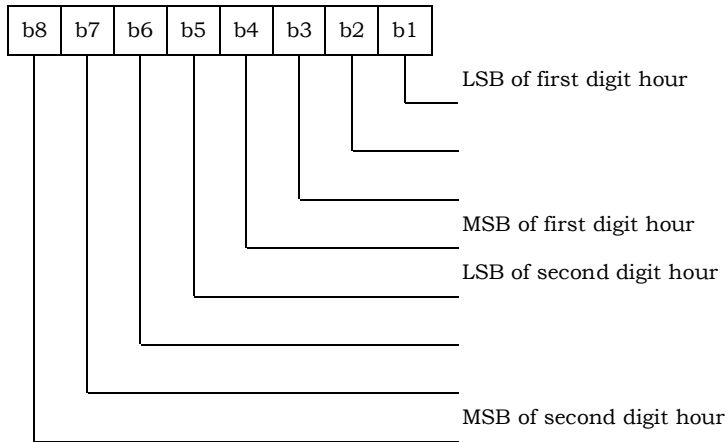

2

3 Byte X+19: Minute

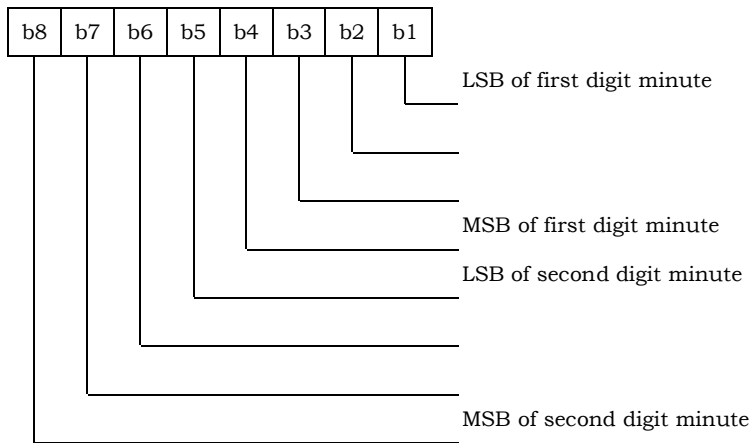

4

5 Byte X+20: Second

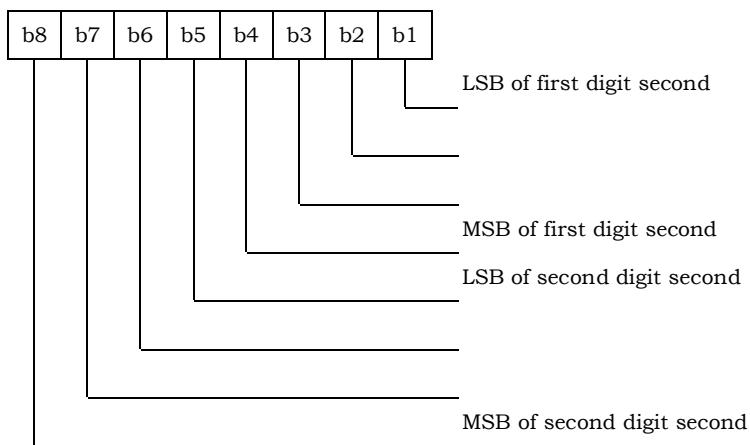

6

1 Byte X+21: Time Zone

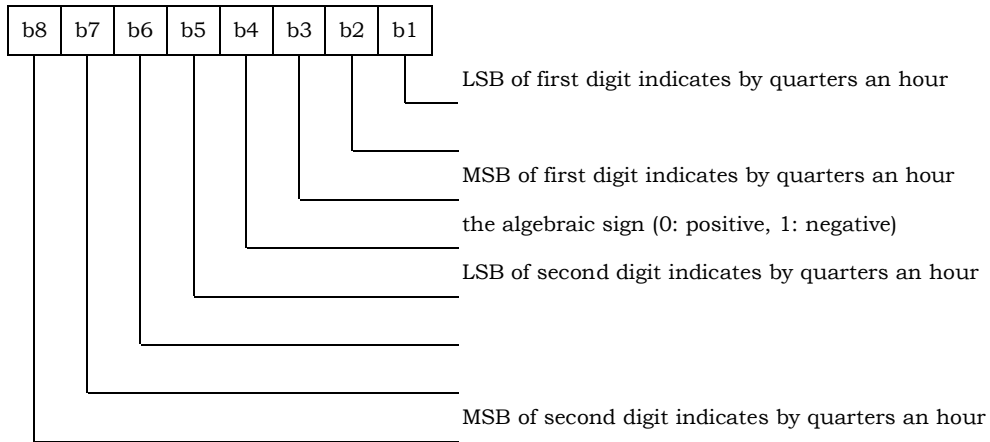

2

3 **Detail 2: Coding of call duration.**

4 Call duration is indicated by second.

5 Byte X+22:

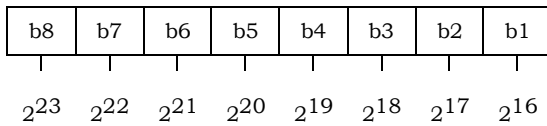

6

7 Byte X+23:

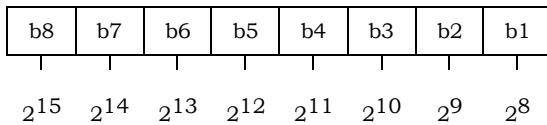

8

9 Byte X+24:

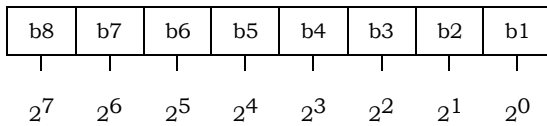

10

11 For instance, '00' '00' '30' represents 2^5+2^4 .

12

1 **Detail 3: Coding of Call status.**

2 Byte X+25:

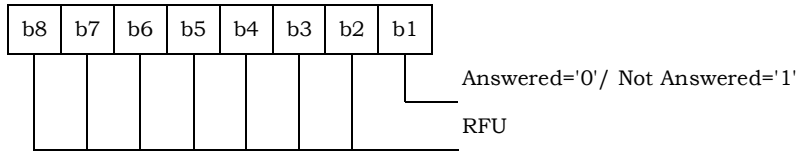

3

4 **Detail 4: Link to phone book entry**

5 For the current implementation of the phone book the following coding applies:

6 Phone book reference.

7 Byte X+26:

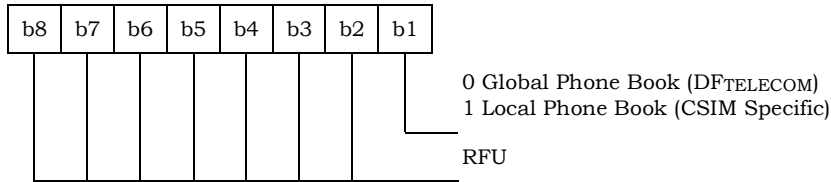

8

9 EF_{PBR} record number:

10 Byte X+27: Hexadecimal value.

11 EF_{ADN} record number:

12 Byte X+28: Hexadecimal value.

13

14

5.2.88 EF_{OCI} (Outgoing Call Information)

If service n27 is "available", this file shall be present.

The outgoing call information can be linked to the phone book stored under DF_{TELECOM} or to the local phone book within the CSIM. The EF_{OCI} contains the information related to outgoing calls.

The time of the call and duration of the call are stored in this EF. It may also contain associated alpha identifier. In addition it contains identifiers of associated network/bearer capabilities and identifiers of extension records at the CSIM ADF level. The structure of this file is cyclic, so the contents shall be updated only after a call is disconnected.

If the dialled phone number matches a number stored in the phone book the outgoing call information might be linked to the corresponding information in the phone book. The dialled number may match with a hidden entry in the phone book. If the dialled number matches a hidden entry in the phone book the link is established but the information related to the phone book entry is not displayed by the ME, if the hidden code has not been verified. The ME shall not perform hidden code verification at this point.

Optionally, the ME may store the link to phone book entry in the file, so that it does not need to look again for a match in the phone book when it reuses the entry. But the ME will have to check that the outgoing call number still exists in the linked phone book entry, as the link might be broken (entry modified). When not used by the ME or no link to the phone book has been found, this field shall be set to 'FFFFFF'.

Coding scheme is according to EF_{ICI}.

Identifier: '6F7D'		Structure: Cyclic		Optional	
SFI: '11'					
Record length: X+27 bytes			Update activity: high		
Access Conditions:					
READ		PIN			
UPDATE		PIN			
DEACTIVATE		ADM			
ACTIVATE		ADM			
Bytes	Description			M/ O	Length
1 to X	Alpha Identifier			O	X bytes
X+1	Length of BCD number/SSC contents			M	1 byte
X+2	TON and NPI			M	1 byte
X+3 to X+12	Outgoing Call Number/SSC String			M	10 bytes

X+13	Capability/Configuration2 (EF _{CCP2}) Record Identifier	M	1 byte
X+14	Extension5 (EF _{EXT5}) Record Identifier	M	1 byte
X+15 to X+21	Outgoing call date and time	M	7 bytes
X+22 to X+24	Outgoing call duration	M	3 bytes
X+25 to X+27	Link to Phone Book Entry	M	3 bytes

1 NOTE: When the contents are invalid, they are filled with 'FF'.

1 5.2.89 EF_{EXT5} (Extension 5)

2 This EF contains extension data of EF_{ICI} and EF_{Oci} of the CSIM application.

3

Identifier: '6F7E'		Structure: linear fixed		Optional
Record length: 13 bytes			Update activity: low	
Access Conditions:				
READ		PIN		
UPDATE		PIN		
DEACTIVATE		ADM		
ACTIVATE		ADM		
Bytes	Description	M/O	Length	
1	Record type	M	1 byte	
2 to 12	Extension data	M	11 bytes	
13	Identifier	M	1 byte	

4

5 For contents and coding see Section 5.4.2 (EF_{EXT1}).

6

1 5.2.90 EF_{CCP2} (Capability Configuration Parameters 2)

2 This EF contains parameters of required network and bearer capabilities and terminal
 3 configurations associated with a call established using a fixed dialling number, a service dialling
 4 number, an incoming call, or an outgoing call. It is referred by EF_{FDN}, EF_{SDN}, EF_{ICI} and EF_{OCl}, at
 5 CSIM ADF level.

6

Identifier: '6F7F'		Structure: linear fixed		Optional	
SFI: '12'					
Record length: X bytes, X≥15			Update activity: low		
Access Conditions:					
READ		PIN			
UPDATE		PIN			
DEACTIVATE		ADM			
ACTIVATE		ADM			
Bytes	Description			M/O	Length
1 to X	Bearer capability information element			M	X bytes

7
 8 Unused bytes are filled with 'FF'.
 9

1 5.2.91 EF_{ICCID} (ICC Identification)

2 EF_{ICCID} is defined in [18] with the following restrictions:

- 3 • This EF shall contain 18 digits of the actual ICCID followed by the check digit and a single
4 0xF filler digit.
- 5 • The ICCID shall be globally unique, using an Issuer Identifier Number registered with the ITU-
6 T as specified in [58].

7

5.2.92 EF_{AppLabels} (Application Labels)

This EF contains text labels that shall be associated with the icons or menu items used to launch applications. These labels are optional and need only be provisioned if an operator desires to override the handset vendor-defined labels.

Identifier: '6F80'		Structure: Transparent		Optional
File size: 4+N*32			Update Activity: Low	
Access Conditions:				
READ		PIN		
UPDATE		ADM		
INVALIDATE		ADM		
REHABILITATE		ADM		
Bytes	Description	M/O	Length	
1	Character Encoding	M	1 byte	
2	Language Indicator	M	1 byte	
3 – 4	Application Labels Present	M	2 bytes	
5 – 36	Application Label ₁	O	32 bytes	
37 – 68	Application Label ₂	O	32 bytes	
...	...	O	...	
5+(N-1)*32 to 36+(N-1)*32	Application Label _N	O	32 bytes	

• **Character Encoding:**

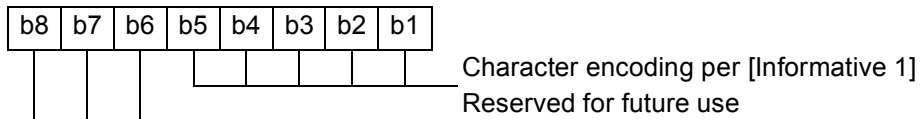

• **Language Indicator:**

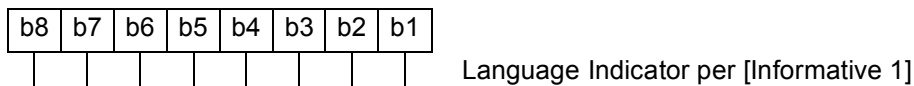

- 1 • **Application Labels Present:** This field is a bitmask used to identify which Application Label
2 Fields are present in the EF. Each bit represents a particular application as shown below:

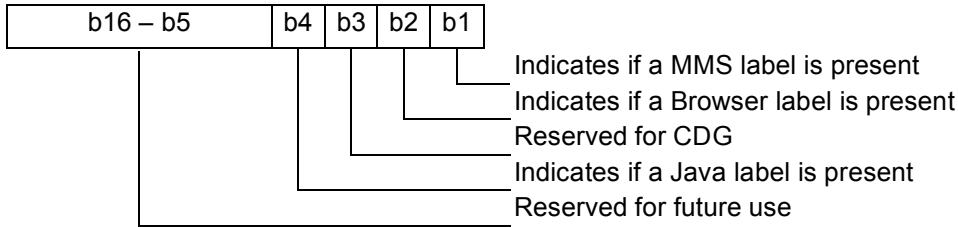

3

4 If a bit is set to '1,' an Application Label Field for that application shall be present. If the bit is
5 set to '0,' an Application Label Field for that application shall not be present and the handset's
6 user interface will display the generic label for that application.

- 7 • **Application Label:** Each Application Label field contains the text label to be displayed with the
8 icon or menu item used to launch that application. The Application Label Present field
9 identifies which Application Label fields are present in the EF. These Application Label fields
10 shall be present in the same order as their corresponding bits in the Application Labels
11 Present field. The string contents of each Application Label field shall use the SMS convention
12 as defined in Tables 9.1-1 and 9.2-1 of [Informative 1]. The string shall be left justified.
13 Unused bytes shall be set to 'FF.'

5.2.93 EF_{Model} (Device Model Information)

This EF contains the model information of the ME. Similar to EF_{ESNME}, this EF is populated by the device during power-up. This EF enables CCAT applications to provide model information to the network either automatically or on demand.

Identifier: '6F81'		Structure: Transparent		Optional	
File Size: 126			Update activity: Low		
Access Conditions:					
READ		PIN			
UPDATE		PIN			
INVALIDATE		ADM			
REHABILITATE		ADM			
Bytes	Description	M/O	Length		
1	Character Encoding	M	1 byte		
2	Language Indicator	M	1 byte		
3-34	Model Information	M	32 bytes		
35-66	Manufacturer Name	M	32 bytes		
67-126	Software Version Information	M	60 bytes		

- Character Encoding:**

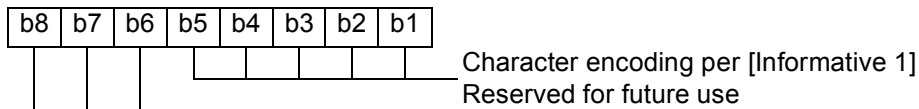

- Language Indicator:**

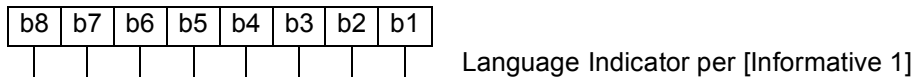

- Model Information:** This field is a string indicating the model name of the device (e.g., "ABCCOM-XYZ"). The string contents shall use the SMS convention as defined in Tables 9.1-1 and 9.2-1 of [Informative 1]. The string shall be left justified. Unused bytes shall be set to 'FF.'
- Manufacturer Name:** This field is a string indicating the manufacturer of the device. The string contents shall use the SMS convention as defined in Tables 9.1-1 and 9.2-1 of [Informative 1]. The string shall be left justified. Unused bytes shall be set to 'FF.'
- Software Version Information:** This field is a string indicating the software version of the device (e.g., "6.0 patch 01"). The string contents shall use the SMS convention as defined in Tables 9.1-1 and 9.2-1 of [Informative 1]. The string shall be left justified. Unused bytes shall be set to 'FF.'

1 5.2.94 EF_{RC} (Root Certificates)

2 If service n36 (Root Certificates) is allocated, this EF shall be present.

3 This EF contains the root certificates for applications on the device. One or more applications are
 4 associated with each certificate.

5

Identifier: '6F82'		Structure: Transparent		Optional
File Size: $X_1 + \dots + X_n$			Update activity: Low	
Access Conditions:				
READ		ALW		
UPDATE		ADM		
INVALIDATE		ADM		
REHABILITATE		ADM		
Bytes	Description	M/O	Length	
1 to X_1	Certificate TLV Object	M	X_1 bytes	
X_1+1 to X_1+X_2	Certificate TLV Object	O	X_2 bytes	
...	...	O	...	
$X_1 + \dots + X_{n-1} + 1$ to $X_1 + \dots + X_n$	Certificate TLV Object	O	X_n bytes	

6

7 Unused bytes shall be set to 'FF.' A Tag value of 'FF' indicates the end of valid data.

1

- **Certificate TLV Object – Contents:**

Description	Value	M/O	Length
Certificate Tag	'80'	M	1 byte
Length	Note 1	M	Note 2
Certificate Type	Note 3	M	1 byte
Certificate Information	Note 4	M	Variable
Applications	Note 3	M	2 bytes
<p>NOTE 1: This is the total size of the constructed TLV object.</p> <p>NOTE 2: The length is coded according to ISO/IEC 8825. It is the overall length of data fields after this Length field.</p> <p>NOTE 3: See coding below.</p> <p>NOTE 4: Binary data for the certificate information as defined in corresponding Certificate Type as defined below, e.g., X.509.</p>			

2

- **Certificate Type – Coding:**

Value	Name	Notes
0	DER Encoded Binary X.509	See section 7 “Public-keys and public-key certificates” in [59] for the definition. The binary encoding is per DER encoding defined in [60].
1	Base64 Encoded X.509	See section 7 “Public-keys and public-key certificates” in [59]. The encoding is per DER encoding defined in [60] and the DER binary data is converted to Base 64 text format.
2	PKCS #7	See section 6.5 “ExtendedCertificateOrCertificate” in [61] for the definition. The binary encoding is per DER encoding defined in [60].
3	PKCS #12	See section 4.2.3 “The CertBag type” in [62] for the definition. The binary encoding is per DER encoding defined in [60].
4-255	Reserved for future use	

3

4

5

6

7

8

- **APPLICATIONS:** This field is a bitmask used to indicate which applications are associated with a particular certificate. If the same certificate is being used for all applications signed by the operator, only bit 1 (Unspecified) will be set. Otherwise, if the operator signs different applications using different certificates, the bit for each application associated with the certificate shall be set. Note that, while each certificate may be associated with multiple applications, each application may only be associated with one certificate.

<u>Bit</u>	<u>Application</u>
1	Unspecified (all applications use the same profile)
2	Reserved
3	WAP Browser
4	Reserved for CDG
5	Java
6	Reserved for CDG
7	Terminal (tethered mode for terminal access)
8-16	Reserved for future use

1 5.2.95 EF_{SMSCAP} (SMS Capabilities)

2 If services n6 (Short Message Storage) and n35 (Messaging and 3GPD Extensions) are allocated,
3 this EF shall be present.

4 This EF contains information about SMS Capabilities.

5

Identifier: '6F83'		Structure: Transparent		Optional
File size: 4 bytes			Update Activity: Low	
Access Conditions:				
READ		PIN		
UPDATE		ADM		
INVALIDATE		ADM		
REHABILITATE		ADM		
Bytes	Description	M/O	Length	
1	SMS Retry Period	M	1 byte	
2	SMS Retry Interval	M	1 byte	
3	SMS Flags	M	1 byte	
4	SMS Preferred Service Option	M	1 byte	

- 6
- 7 • **SMS Retry Period:** This is the overall time period (in seconds) during which the Mobile
8 Originated (MO) SMS retries can be performed. 0 means that MO SMS retry is disabled.
 - 9 • **SMS Retry Interval:** This is the time interval (in seconds) that the device shall wait before the
10 next retry attempt can be made after a MO SMS failure.
 - 11 • **SMS Flags:** 0 – disabled; 1 – enabled

<u>Bit</u>	<u>Parameter Indicated</u>
1	Send On Access (Allow MO SMS to be sent over Access Channel)
2	Send On Traffic (Allow MO SMS to be sent over Traffic Channel)
3	Send as Standard EMS (Network supports standard EMS per [8])
4-8	Reserved for future use

- 12 • **SMS Preferred Service Option:** This is the preferred service option to be used when the device
13 sets up SMS traffic channel for sending messages.

<u>Value</u>	<u>Description</u>
0	Device Default
1	Service Option 6
2	Service Option 14
3-255	Reserved for future use

1 5.2.96 EF_{MIPFlags} (MobileIP Flags)

2 If services n15 (3GPD-MIP) and n35 (Messaging and 3GPD Extensions) are allocated, this EF shall
 3 be present.

4 This EF contains the configuration flags for Mobile IP.

5

Identifier: '6F84'		Structure: Transparent		Optional
File size: 1 byte			Update Activity: Low	
Access Conditions:				
READ		PIN		
UPDATE		ADM		
INVALIDATE		ADM		
REHABILITATE		ADM		
Bytes	Description	M/O	Length	
1	MIP_FLAGS	M	1 byte	

6

- 7 • **MIP_FLAGS:** 0 – disabled; 1 – enabled

<u>Bit</u>	<u>Parameter Indicated</u>
1	Mobile IP 2002bis MN HA Authentication
2	Mobile IP Pre Rev 6 handoff optimization
3	Mobile IP PPP Re-sync during hand-down from 1xEV-DO Rev 0 to 1x
4	Mobile IP Re-registration only if data has been transferred since last registration in order to extend Mobile IP address lifetime
5-8	Reserved for future use

8

1 5.2.97 EF_{SIPUPPExt} (SimpleIP User Profile Parameters Extension)

2 If services n14 (3GPD-SIP) and n35 (Messaging and 3GPD Extensions) are allocated, this EF shall
3 be present.

4 This EF contains the additional parameters for Simple IP User Profiles in order to fully support the
5 feature of multiple profiles.

6

7

Identifier: '6F85'		Structure: Transparent		Optional
File size: X bytes			Update Activity: Low	
Access Conditions:				
READ		PIN		
UPDATE		ADM		
INVALIDATE		ADM		
REHABILITATE		ADM		
Bytes	Description	M/O	Length	
X	UPP Extension Block	M	X bytes	

8

9 Unused bytes shall be set to 'FF.'

10 • **UPP Extension Block structure:**

Field	Length (bits)
NUM_NAI	4

NUM_NAI occurrences of the following fields:

NAI_ENTRY_INDEX	4
APPLICATIONS	32
PRIORITY	8
DATA_RATE_MODE	4
DATA_BEARER	4

RESERVED	0 or 4
----------	--------

- 11
- 12 • **NUM_NAI:** Number of UPP Extension instances. This number shall be the same as NUM_NAI
13 in the base user profile EF (EF_{SIPUPP} or EF_{MIPUPP}).

- 1 • **NAI_ENTRY_INDEX:** Index to the list of UPP Extension instances. This index shall point to the
2 UPP Extension instance that is corresponding to the base UPP instance with the same index
3 value as defined in EF_{SIPUPP} or EF_{MIPUPP}.
- 4 • **APPLICATIONS:** This field is a bitmask used to indicate which applications are associated
5 with a particular profile. The applications shall use the profile having the “Unspecified” bit set
6 in the APPLICATIONS bitmask if they are not present in any other profiles.

<u>Bit</u>	<u>Application</u>
1	Unspecified (<i>used by applications not present in any other profile</i>)
2	MMS
3	WAP Browser
4	Reserved for CDG
5	Java
6	Reserved for CDG
7	Terminal (<i>tethered mode for terminal access</i>)
8-32	Reserved for future use

- 7 • **PRIORITY:** When attempting to launch a new application, it is possible that another
8 application is already active and has already established a data session. If the new application
9 has the same PRIORITY value as the previous application that established the existing data
10 session, the new application may simply reuse the existing data session.

11 If the new application has a different PRIORITY than the previous application that set up the
12 existing data session, the device may use the PRIORITY to determine which application has
13 higher priority, as follows:

<u>Value</u>	<u>Priority</u>
0	Highest priority category
1	Second highest priority category (lower than 0; higher than 2 and others)
2	Third highest priority category (lower than 0 or 1; higher than 3 and others)
:	:
255	Lowest priority

- 14
- 15 • **DATA_RATE_MODE:** Data Rate Mode

<u>Value</u>	<u>Application</u>
0	Low Speed: Low speed service options only
1	Medium Speed: F-SCH with service option 33 only
2	High Speed: F-SCH and R-SCH with service option 33
3-15	Reserved for future use

- 1 • **DATA_BEARER:** Data Bearer

<u>Value</u>	<u>Application</u>
0	Hybrid 1x/1xEV-DO
1	1x only
2	1xEV-DO only
3-15	Reserved for future use

2

1 5.2.98 EF_{MIPUPPExt} (MobileIP User Profile Parameters Extension)

2 If services n15 (3GPD-MIP) and n35 (Messaging and 3GPD Extensions) are allocated, this EF shall
 3 be present.

4 This EF contains the additional parameters for Mobile IP User Profiles in order to fully support the
 5 feature of multiple profiles for Mobile IP.

6

Identifier: '6F86'		Structure: Transparent		Optional
File size: X bytes			Update Activity: Low	
Access Conditions:				
READ		PIN		
UPDATE		ADM		
INVALIDATE		ADM		
REHABILITATE		ADM		
Bytes	Description	M/O	Length	
X	UPP Extension Block	M	X bytes	

7

8 The UPP Extension Block is used by both EF_{SIPUPPExt} for Simple IP and EF_{MIPUPPExt} for Mobile IP. See
 9 the definition of EF_{SIPUPPExt} for the definition of the UPP Extension Block.

10

1 5.2.99 EF_{IPv6CAP} (IPv6 Capabilities)

2 If services n35 (Messaging and 3GPD Extensions) and n41 (IPv6) are allocated, this EF shall be
3 present.

4 This EF contains information about IPv6 capabilities.

5

Identifier: '6F87'		Structure: Transparent		Optional
File size: 21 bytes		Update Activity: Low		
Access Conditions:				
READ		PIN		
UPDATE		ADM		
INVALIDATE		ADM		
REHABILITATE		ADM		
Bytes	Description	M/O	Length	
1-2	Initial neighbor solicitation delay time	M	2 bytes	
3-4	Solicitation interval	M	2 bytes	
5-6	Re-solicitation interval	M	2 bytes	
7-8	Maximum solicitation attempts	M	2 bytes	
9-10	Maximum re-solicitation attempts	M	2 bytes	
11-12	Pre-RA expiry re-solicitation time	M	2 bytes	
13-20	IID Information	M	8 bytes	
21	IPv6 Flags	M	1 byte	

- 6
- 7 • **Initial neighbor solicitation delay time** (*in units of 100ms*): Time mobile waits after the IID
8 (Interface ID) has been negotiated before sending an RS (Router Solicitation) in an attempt to
9 receive an RA (Router Advertisement).

1 **Coding:** 16-bit integer.

2 Byte 1:

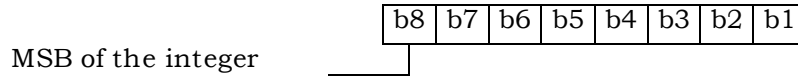

3 Byte 2:

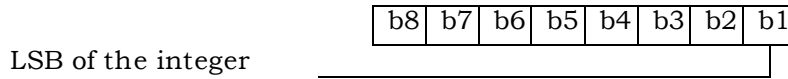

4

- 5 • **Solicitation interval** (*in units of 100ms*): Amount of time the mobile waits before sending a
6 subsequent RS after a previous one.

7 **Coding:** 16-bit integer.

8 Byte 1:

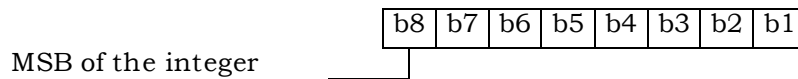

9 Byte 2:

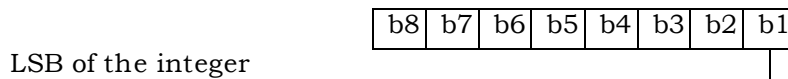

10

- 11 • **Re-solicitation interval** (*in units of 100ms*): Amount of time between solicitations sent while re-
12 soliciting for a new RA. This interval applies only after the mobile has previously received one
13 valid RA and is soliciting for a new one to renew the lifetimes of the current prefix or retrieve a
14 non-deprecated prefix.

15 **Coding:** 16-bit integer.

16 Byte 1:

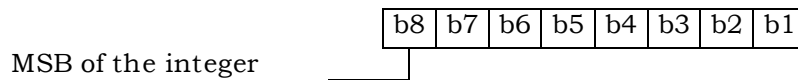

17 Byte 2:

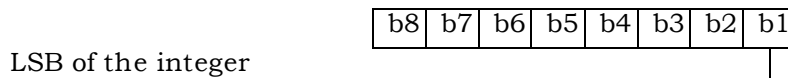

18

- 1 • **Max solicitation attempts:** Number of solicitation attempts to make for initial IPv6 session
 2 establishment, when an RA is not received in response before giving up IPv6 auto-
 3 configuration.

4 **Coding:** 16-bit integer.

5 Byte 1:

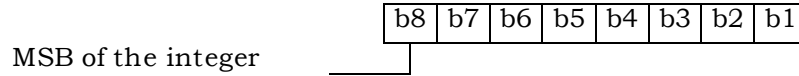

6 Byte 2:

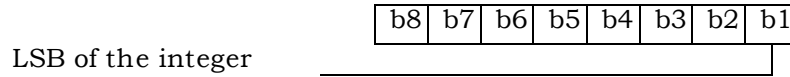

7

- 8 • **Max re-solicitation attempts:** Number of solicitation attempts to make to re-solicit for a new
 9 RA.

10 **Coding:** 16-bit integer.

11 Byte 1:

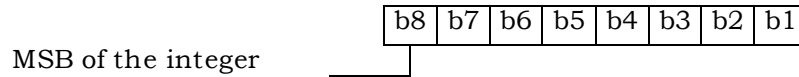

12 Byte 2:

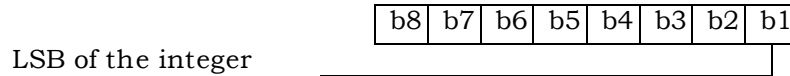

13

- 14 • **Pre-RA expiry re-solicitation time** (*in units of 100ms*): Amount of time before the current RA
 15 expires to begin re-solicitations.

16 **Coding:** 16-bit integer.

17 Byte 1:

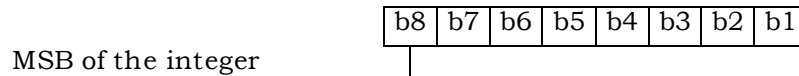

18 Byte 2:

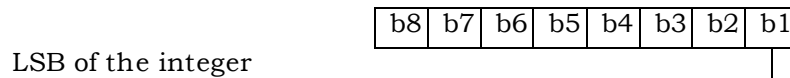

19

- 20 • **IID Information:** IID is part of the IPv6 address. See [63] for information on coding.

- 1
- **IPv6 Flags:** Identify IPv6 behavior. Coding (0 – Disabled; 1 – Enabled).

<u>Bit</u>	<u>Parameter Indicated</u>
1	Use IPv6
2	Failover from IPv6 to IPv4
3	PDSN as proxy IPv6 DNS server. When enabled, the mobile forwards all DNS requests to the PDSN. The PDSN forwards requests to the appropriate DNS server. This parameter is meaningful only if the primary and secondary DNS server addresses are not available.
4-8	Reserved for future use

2

1 5.2.100 EF_{TCPConfig} (TCP Configurations)

2
3 If service n14 (3GPD-SIP) or n15 (3GPD-MIP) is allocated and service n35 (Messaging and 3GPD
4 Extensions) is allocated, this EF shall be present.

5 This EF contains information about Transmission Control Protocol configurations.

6

Identifier: '6F88'		Structure: Transparent		Optional
File size: 2 bytes			Update Activity: Medium	
Access Conditions:				
READ		PIN		
UPDATE		ADM		
INVALIDATE		ADM		
REHABILITATE		ADM		
Bytes	Description	M/O	Length	
1	TCP Flags	M	1 byte	
2	TCP Keep-Alive Idle Timer	M	1 byte	

- 7
8 • **TCP Flags:** Coding (0 – Disabled; 1 – Enabled):

<u>Bit</u>	<u>Parameter Indicated</u>
1	TCP Graceful close of dormant connections
2-8	Reserved for future use

- 9 • **TCP Keep-Alive Idle Timer:** Coding: Number of minutes. A value of 0 means that the TCP
10 keep-alive feature is disabled on the ME.

1 5.2.101 EF_{DGC} (Data Generic Configurations)

2 If service n14 (3GPD-SIP) or n15 (3GPD-MIP) is allocated and service n35 (Messaging and 3GPD
3 Extensions) is allocated, this EF shall be present.

4 This EF contains miscellaneous data configuration items.

5

Identifier: '6F89'		Structure: Transparent		Optional
File size: 3 bytes			Update Activity: Medium	
Access Conditions:				
READ		PIN		
UPDATE		ADM		
INVALIDATE		ADM		
REHABILITATE		ADM		
Bytes	Description	M/O	Length	
1	Data dormant timer	M	1 byte	
2	EPZID Type Information	M	1 byte	
3	Hysteresis Activation Time	M	1 byte	

6

- 7 • **Data dormant timer:** Number of seconds to wait before going into data dormant mode, which
8 shall be at least 20 seconds.
- 9 • **EPZID Type Information:** Contains the Extended Packet Zone ID Types.

Value	Description
0	Packet Zone ID
1	Packet Zone ID plus SID
2	Packet Zone ID plus SID and NID
3-255	Reserved for future use

10

- 11 • **Hysteresis Activation Time:** This is the number of seconds that the device should wait before
12 it goes into hysteresis state and adds new Packet Zone IDs to the packet zone list as needed.
13 See [65] for details on usage of this timer.

14

1 5.2.102 EF_{WAPBrowserCP} (WAP Browser Connectivity Parameters)

2 If service n37 (WAP Browser) is allocated, this EF shall be present.

3 This EF contains the connectivity parameters for a WAP Browser application, such as Gateway
 4 and Home URL information. At least one gateway shall be configured in this EF as the primary
 5 gateway for browsing. Additional gateways as part of the additional instances of Connectivity
 6 Parameters can be optionally configured as secondary gateways in the order of priority as they
 7 appear in this EF.

8

Identifier: '6F8A'		Structure: Transparent		Optional	
File Size: $X_1 + \dots + X_n$			Update activity: Low		
Access Conditions:					
READ		PIN			
UPDATE		ADM			
INVALIDATE		ADM			
REHABILITATE		ADM			
Bytes	Description			M/O	Length
1 to X_1	WAP Browser Connectivity Parameters TLV object			M	X_1 bytes
$X_1 + 1$ to $X_1 + X_2$	WAP Browser Connectivity Parameters TLV object			O	X_2 bytes
...	...				
$X_1 + \dots + X_{n-1} + 1$ to $X_1 + \dots + X_n$	WAP Browser Connectivity Parameters TLV object			O	X_n bytes

9

10 Unused bytes shall be set to 'FF.' A Tag value of 'FF' indicates the end of valid data.

11

12 • **WAP Browser Connectivity Parameters Tags:**

Description	Tag Value
WAP Browser Connectivity Parameters Tag	'AC'
Gateway Tag	'83'
HomeURL Tag	'80'

1 • **WAP Browser Connectivity Parameters TLV Object contents:**

Description	Value	M/O	Length (bytes)
WAP Browser Connectivity Parameters Tag	'AC'	M	1
Length	Note 1	M	Note 1
Gateway Tag	'83'	O	1
Gateway Length	Z	O	Note 2
Gateway Information	--	O	Z
HomeURL Tag	'80'	M	1
HomeURL Length	X	M	Note 2
HomeURL Information	--	M	X
NOTE 1: This is the total size of the constructed TLV object.			
NOTE 2: The length is coded according to ISO/IEC 8825.			

2

- 3 • **Gateway Tag:** This contains information needed to access the WAP Gateway/Proxy server. See
 4 description of EF_{MMSICP} for the definition of Gateway TLV Object.
- 5 • **HomeURL Tag:** This contains the URL for the WAP Browser's home page for the current
 6 particular connectivity parameters. For contents and syntax of URL TLV data object values,
 7 see [52]. The URL shall be encoded to an octet string according to UTF-8 encoding rules as
 8 specified in [46].

9

1 5.2.103 EF_{WAPBrowserBM} (WAP Browser Bookmarks)

2 If service n37 (WAP Browser) is allocated, this EF shall be present.

3 This EF contains bookmarks that may be provisioned by the operator and/or updated by the user.

4

Identifier: '6F8B'		Structure: Transparent		Optional
File Size: Variable			Update activity: High	
Access Conditions:				
READ		PIN		
UPDATE		PIN		
INVALIDATE		ADM		
REHABILITATE		ADM		
Bytes	Description	M/O	Length	
1 to X ₁	Bookmark TLV object	M	X ₁ bytes	
X ₁ +1 to X ₁ +X ₂	Bookmark TLV Object	O	X ₂ bytes	
...	...	O	...	
X ₁ +X ₂ +...+X _{n-1} +1 to X ₁ +X ₂ +...+X _{n-1} +X _n	Bookmark TLV Object	O	X _n bytes	

5
6 Unused bytes shall be set to 'FF.' A value of 'FF' in place of Bookmark Tag field indicates the end
7 of valid data.

8 • **Bookmark TLV object contents:**

Description	Value	M/O	Length (bytes)
Bookmark Tag	'AD'	M	1
Length	Note 1	M	Note 2
URL Tag	'80'	M	1
Length	Y	M	Note2
URL Information	--	M	Y
Bookmark Name Tag	'81'	O	1
Length	Z	O	Note2
Bookmark Name Information	--	O	Z

NOTE 1: This is the total size of the constructed TLV object.
NOTE 2: The length is coded according to ISO/IEC 8825.

- 1 • **URL Information:** For contents and syntax of URL TLV data object values, see [52]. The URL
2 shall be encoded to an octet string according to UTF-8 encoding rules, as specified in [46].
- 3 • **Bookmark Name Information:** This field shall be encoded to an octet string according to
4 UTF-8 encoding rules as specified in [46].

1 5.2.104 EF_{MMSConfig} (MMS Configuration)

2 If services n19 (Multimedia Messaging Service) and n35 (Messaging and 3GPD Extensions) are
3 allocated, this EF shall be present.

4 This EF contains the configuration of MMS.

5 Note that this EF does not contain configuration associated with how the MMS client connects to
6 the MMS service. This type of configuration information is included in the MMS Issuer
7 Connectivity Parameters EF (EF_{MMSICP}).

8

Identifier: '6F8C'		Structure: Transparent		Optional
File size: 8 bytes		Update Activity: Medium		
Access Conditions:				
READ	PIN			
UPDATE	ADM			
INVALIDATE	ADM			
REHABILITATE	ADM			
Bytes	Description	M/O	Length	
1-4	Max Message Size Value	M	4 bytes	
5	Retry Times Value	M	1 byte	
6	Retry Interval Value	M	1 byte	
7-8	MMSC Timeout Value	M	2 bytes	

9

- 1 • **Max Message Size:** This is the maximum MMS message size (in bytes) allowed by the operator.
2 Coding: 32-bit integer.

3 Byte 1:

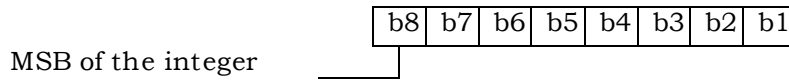

4 Byte 2:

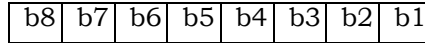

5 Byte 3:

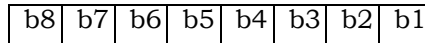

6 Byte 4:

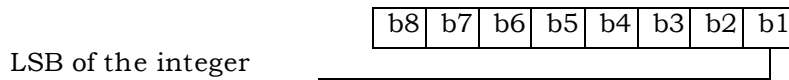

- 7 • **Retry Times:** This is the number of times the MMS application will retry for sending a
8 message. Coding: 8-bit integer.
- 9 • **Retry Interval:** This is the number of seconds to wait before the next retry is attempted.
10 Coding: 8-bit integer.
- 11 • **MMSC Timeout:** This is the number of seconds for the device to wait for response from Mobile
12 Messaging Service Center (MMSC) before declaring it as an MMSC timeout.

13 **Coding:** 16-bit integer.

14 Byte 1:

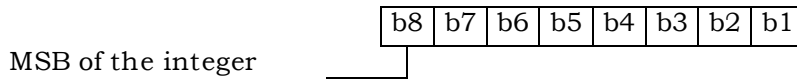

15 Byte 2:

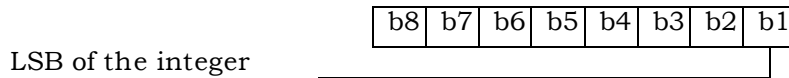

16

17

18

19

20

1 5.2.105 EF_{JDL} (Java Download URL)

2 If service n38 (Java) is allocated, this EF shall be present.

3 This EF contains the information for downloading Java applications from the Java download
4 server.

5

Identifier: '6F8D'		Structure: Transparent		Optional
File size: Variable			Update Activity: Low	
Access Conditions:				
READ		PIN		
UPDATE		ADM		
INVALIDATE		ADM		
REHABILITATE		ADM		
Bytes	Description	M/O	Length	
1-X	Java Download URL	M	X bytes	

6 Unused bytes shall be set to 'FF.'

- 7
- 8 • **Java Download URL:** This contains the URL for the Java download server. For contents and
9 syntax, see [52]. The URL shall be encoded to an octet string according to UTF-8 encoding
10 rules, as specified in [46]. This string shall be NULL terminated.
- 11

1 **5.3 Contents of DFs at the CSIM ADF (Application DF) level**

2 DFs may be present as child directories of CSIM ADF. For this revision, the following DF is
3 defined:

- 4 - DF_{PHONEBOOK} '5F3A'.

5 (DF for application specific phonebook. This DF has the same structure as the DF_{PHONEBOOK} under
6 DF_{TELECOM}).

7
8 Note: The DF_{PHONEBOOK} under CSIM ADF (DF for application specific phonebook) has the same
9 structure as the DF_{PHONEBOOK} under DF_{TELECOM}.

10
11 5.3.1 Contents of files at the DF_{PHONEBOOK} level

12 The DF_{PHONEBOOK} for CSIM shall comply with all requirements specified in [30] Section 4.4.2, with a
13 restriction that SFI shall not apply to the CSIM. In the context of 3GPP2 systems, "USIM" and
14 "SIM" shall be interpreted as "CSIM" and "R-UIM" respectively.

15

5.4 Contents of EFs at the DF_{TELECOM} level

5.4.1 EF_{ADN} (Abbreviated dialling numbers)

In case of a present DF_{CDMA} [46] on the UICC, the first EF_{ADN} (i.e. reflected by the first record in EF_{PBR}) of the DF_{PHONEBOOK} is mapped (with an identifier equal to '6F3A') to DF_{TELECOM} to ensure backwards compatibility.

An ME shall not access this file. The information is accessible for the ME in EF_{ADN} under DF_{PHONEBOOK}.

5.4.2 EF_{EXT1} (Extension 1)

In case of a present DF_{CDMA} [46] on the UICC, the first EF_{EXT1} (i.e. reflected by the first record in EF_{PBR}) of the DF_{PHONEBOOK} is mapped (with an identifier equal to '6F4A') to DF_{TELECOM} to ensure backwards compatibility.

An ME shall not access this file. The information is accessible for the ME in EF_{EXT1} under DF_{PHONEBOOK}.

5.4.3 EF_{ECCP} (Extended Capability Configuration Parameter)

In case of a present DF_{CDMA} application on the UICC, the first EF_{CCP1} (i.e. reflected by the first record in EF_{PBR}) of the DF_{PHONEBOOK} is mapped (with an identifier equal to '6F4F') to DF_{TELECOM} to ensure backwards compatibility. There shall not be any EF_{CCP} (with a file-id of '6F3D') under DF_{TELECOM} because otherwise a R-UIM ME could create inconsistencies within the phonebook.

An ME shall not access this file. The information is accessible for the ME in EF_{CCP1} under DF_{PHONEBOOK}.

5.4.4 EF_{SUME} (Set Up Menu Elements)

This File is defined in [54], and has the file identifier '6F54'.

5.4.5 EF_{ARR} (Access Rule Reference)

This EF contains the access rules for files located under the DF_{TELECOM} in the UICC. If the security attribute tag '8B' is indicated in the FCP it contains a reference to a record in this file.

This EF contains one or more records containing access rule information according to the reference to expanded format as defined in [53]. Each record represents an access rule. Unused bytes in the record are set to 'FF'.

1 If the card cannot access EF_{ARR} , any attempt to access a file with access rules indicated in this
2 EF_{ARR} shall not be granted.

3

4

5.5 Contents of DFs at the DF_{TELECOM} level

DFs may be present as child directories of DF_{TELECOM}. The following DFs have been defined:

- DF_{GRAPHICS} '5F50'.
- DF_{PHONEBOOK} '5F3A'.

(DF for public phone book. This DF has the same structure as DF_{PHONEBOOK} under ADF CSIM).

- DF_{MULTIMEDIA} '5F3B'.

5.5.1 Contents of files at the DF_{GRAPHICS} level

The DF_{GRAPHICS} for CSIM shall comply with all requirements specified in [30] Section 4.6.1.

5.5.2 Contents of files at the DF_{PHONEBOOK} under the DF_{TELECOM}

This DF has the same structure as DF_{PHONEBOOK} under the ADF_{CSIM}.

5.5.3 Contents of files at the DF_{MULTIMEDIA} level

The EFs in the DF_{MULTIMEDIA} contain multimedia information. This DF shall be present if service n30 is available, i.e. if the card supports MMS storage.

The EFs in the DF_{MULTIMEDIA} for CSIM shall comply with all requirements specified in [30] Section 4.6.3.1. In the context of 3GPP2 systems, reference to [Informative 2] and [Informative 3] shall be interpreted as a reference to [45] and [37] respectively.

6. INTERWORKING OF R-UIM & CSIM APPLICATION ON A UICC

An R-UIM [46] and a CSIM implemented together on a single UICC can never be activated at the same time. Neither can they be switched from one to the other. Their activities solely depend on the functionality of ME in which they are inserted: a ME supporting the CSIM shall use the CSIM rather than the R-UIM.

However, both applications may share certain elements to optimize memory consumption, but still, both applications have to be virtually independent from the functional point of view. The following section describes the possible options.

6.1 File Mapping

Many files of R-UIM [46] and CSIM not only have the same name and file identifier (although under different DFs) but are entirely equal by size and content parameters. This generally allows for memory efficient implementation of a CSIM together with an R-UIM, as these files can be shared by both applications, i.e. necessary storage capacity is only required once. Further, shared files speeds up the pre-personalization process as they save valuable programming time.

Therefore, files should be mapped as far as possible, i.e. in all cases where basic properties are equal and identical contents do not conflict with the access by either an R-UIM or a CSIM based ME or with intended subscription differences when separate IMSIs are used.

Annex A gives an overview of the rules for mapping files between an R-UIM and CSIM. A case by case decision should be conducted by the network operator / card manufacturer for each UICC implementation.

Caution: It should be noted that file identifiers may differ between the R-UIM and CSIM, while all other file properties are exactly the same.

6.2 Reserved

6.3 Access conditions

If an EF is accessible in both CSIM and R-UIM operation modes, independent UICC and non-UICC access conditions may be defined for the file. The UICC does not check the consistency of the access conditions in both modes.

Therefore, it is possible that the same EF has different security attributes in UICC and non-UICC operation modes. It is the responsibility of the network operator and the card manufacturer to ensure at the personalization stage that the security attributes for a UICC and non-UICC session are the same, if necessary.

6.4 Reserved

7. APPLICATION PROTOCOL

The requirements stated in the corresponding section of [45] apply to the CSIM application.

The procedures listed in Section 7.1, "CSIM management procedures," are required for execution of the procedures in the Section 7.2, "CSIM security related procedures," and Section 7.3, "Subscription Related Procedures". The procedures listed in Section 7.2, "CSIM security related procedures," are mandatory. The procedures listed in Section 7.3, are only executable if the associated services, which are optional, are provided in the CSIM. However, if the procedures are implemented, it shall be in accordance with Section 7.3.

7.1 CSIM management procedures

If a CSIM application is present on the UICC, a ME shall only use the CSIM application. In this case, a possibly existing R-UIM shall never be used by a ME.

7.1.1 Initialization

7.1.1.1 CSIM Application Selection

After UICC activation (see [45]), the ME selects a CSIM application. If no EFDIR file is found or no CSIM applications are listed in the EFDIR file, the ME may then try to select the R-UIM as specified in [46]. After a successful CSIM application selection, it is the UICC's responsibility to store the selected CSIM (AID) on the UICC. This application is referred to as the last selected CSIM application. The last selected CSIM application shall be available on the UICC after a deactivation followed by an activation of the UICC.

If a CSIM application is selected using partial DF name, the partial DF name supplied in the command shall uniquely identify a CSIM application. Furthermore if a CSIM application is selected using a partial DF name as specified in [45] indicating in the SELECT command the last occurrence the UICC shall select the CSIM application stored as the last CSIM application. If, in the SELECT command, the options first, next/previous are indicated, they have no meaning if an application has not been previously selected in the same session and shall return an appropriate error code.

7.1.1.2 CSIM Initialization

The CSIM application shall not indicate any language preference. It shall use the language indicated by any other application currently active on the UICC or by default, choose a language from EFPL at the MF level according the procedure defined in [45].

If the ME does not support the languages of EFPL, then the ME shall use its own internal default selection.

The ME then runs the user verification procedure. If the procedure is not performed successfully, the CSIM initialization stops.

Then the ME performs the administrative information request.

The ME performs the CSIM Service Table request.

The ME performs the Enabled Services Table request.

1 The ME reads the Administrative Data.

2 The ME reads the Removable UIM_ID

3 The ME sends the “Store_ESN_MEID_ME” command.

4 If all these procedures have been performed successfully then CSIM session shall start. In all
5 other cases CSIM session shall not start.

6 Afterwards, the ME runs the following procedures if the ME and the CSIM support the related
7 services:

8 - Service Preferences;

9 - IMSI Request;

10 - Access Overload Class information request;

11 - Preferred Roaming List request;

12 - Depending on the further services that are supported by both the ME and the CSIM the
13 corresponding EFs have to be read.

14 After the CSIM initialization has been completed successfully, then ME is ready for a CSIM
15 session and shall indicate this to the CSIM by sending a particular STATUS command [18].

16

17 7.1.2 Session Termination

18 NOTE 1: This procedure is not to be confused with the deactivation procedure in defined in [45].

19 The ME shall indicate to the CSIM by sending a particular STATUS command [18] that the
20 termination procedure is starting.

21 The ME then runs all the procedures which are necessary to transfer the following subscriber
22 related information to the CSIM:

23 - Key update.

24 Finally, the ME deletes all these subscriber related information elements from its memory.

25 To actually terminate the session, the ME shall then use one of the mechanisms described in [45].

26

27 7.1.3 CSIM Application Closure

28 After termination of the CSIM application session as defined in 7.1.2, the CSIM application may be
29 closed by closing the logical channels that are used to communicate with this particular CSIM
30 application.

31

7.1.4 Emergency call codes

Request: The ME performs the reading procedure with EF_{ECC} . If EF_{ECC} does not contain any valid number, the ME shall use the emergency numbers it stores for use in setting up an emergency call without a CSIM application.

Update: The ME performs the updating procedure with EF_{ECC} .

NOTE: The update procedure is only applicable when the access condition of ADM for "UPDATE" is set to ALW, PIN or PIN2.

7.1.5 Language indication

Request: The ME performs the reading procedure with EF_{LI} .

Update: The ME performs the updating procedure with EF_{LI} .

7.1.6 Administrative information request

The ME performs the reading procedure with EF_{AD} .

7.1.7 CSIM Service Table request

The ME performs the reading procedure with EF_{CST} .

7.2 CSIM Security Related Procedures

All the security related procedures defined in [46] is applicable to this CSIM application.

7.3 Subscription Related Procedures

7.3.1 Phone book procedure

The Phone book procedures for CSIM shall comply with all requirements specified in [30] Section 5.3.1.

7.3.2 Dialing numbers

Requirements:

- Service n1 "available" for ADN located under the local phonebook;

- 1 - Presence of EF_{ADN} in EF_{PBR} for ADN located under the global phonebook;
- 2 - Presence of EF_{ANR} in EF_{PBR} for ANR;
- 3 - Service n2 "available" for FDN;
- 4 - Service n4 "available" for SDN;
- 5 - Service n27 "available" for EF_{OCI};
- 6 - Service n28 "available" for EF_{ICI}.

7 The following procedures may not only be applied to EF_{ADN} and its associated extension files EF_{CCP1}
8 and EF_{EXT1} as described in the procedures below, but also to EF_{ANR}, EF_{FDN}, EF_{SDN}, EF_{OCI}, and EF_{ICI},
9 and their associated extension files. If these files are not available, as denoted in the CSIM service
10 table, the current procedure shall be aborted and the appropriate EFs shall remain unchanged.

11 As an example, the following procedures are described as applied to ADN.

12 Update: The ME analyzes and assembles the information to be stored as follows (the byte
13 identifiers used below corresponds to those in the definition of the relevant EFs in the
14 present document):

- 15 i) The ME identifies the Alpha-tagging, Capability/Configuration1 Record Identifier and
16 Extension1 Record Identifier.
- 17 ii) The dialing number/SSC string shall be analyzed and allocated to the bytes of the EF
18 as follows:
 - 19 - if a "+" is found, the TON identifier is set to "International";
 - 20 - if 20 or less "digits" remain, they shall form the dialing number/SSC string;
 - 21 - if more than 20 "digits" remain, the procedure shall be as follows:
 - 22 - The ME seeks for a free record in EF_{EXT1}. If an Extension1 record is not marked as
23 "free", the ME runs the Purge procedure. If an Extension1 record is still unavailable,
24 the procedure is aborted.
 - 25 - The first 20 "digits" are stored in the dialing number/SSC string. The value of the
26 length of BCD number/SSC contents is set to the maximum value, which is 11. The
27 Extension1 record identifier is coded with the associated record number in the
28 EF_{EXT1}. The remaining digits are stored in the selected Extension1 record where the
29 type of the record is set to "additional data". The first byte of the Extension1 record
30 is set with the number of bytes of the remaining additional data. The number of
31 bytes containing digit information is the sum of the length of BCD number/SSC
32 contents of EF_{ADN} and byte 2 of all associated chained Extension1 records
33 containing additional data.

1 iii) If a called party subaddress is associated to the ADN/SSC the procedure shall proceed
2 as follows:

- 3 - If the length of the called party subaddress is less than or equal to 11 bytes:
- 4 - The ME seeks for a free record in EF_{EXT1}. If an Extension1 record is not marked as
5 "free", the ME runs the Purge procedure. If an Extension1 record is still unavailable,
6 the procedure is aborted.
- 7 - The ME stores the called party subaddress in the Extension1 record, and sets the
8 Extension1 record type to "called party subaddress".
- 9 - If the length of the called party subaddress is greater than 11 bytes:
- 10 - The ME seeks for two free records in EF_{EXT1}. If no such two records are found,
11 the ME runs the Purge procedure. If two Extension1 records are still unavailable,
12 the procedure is aborted.
- 13 - The ME stores the called party subaddress in the two Extension1 records. The
14 identifier field in the Extension1 record containing the first part of the
15 subaddress data is coded with the associated EF_{EXT1} record number containing
16 the second part of the subaddress data. Both Extension1 record types are set to
17 "called party subaddress".

18 Once i), ii), and iii) have been considered the ME performs the updating procedure with EF_{ADN}. If the
19 CSIM has no available empty space to store the received ADN/SSC, or if the procedure has been
20 aborted, the ME advises the user.

21 For reasons of memory efficiency, the ME may analyze all Extension1 records to recognize if the
22 additional or subaddress data to be stored already exists in EF_{EXT1}. In this case, the ME may use the
23 existing chain or the last part of the existing chain from more than one ADN. The ME is only allowed
24 to store extension data in unused records. If existing records are used for multiple accesses, the ME
25 shall not change any data in those records to prevent corruption of existing chains.

26 Erasure: The ME sends the identification of the information to be erased. The content of the
27 identified record in EF_{ADN} is marked as "free".

28 Request: The ME sends the identification of the information to be read. The ME shall analyze
29 the data of EF_{ADN} to ascertain, whether additional data is associated in EF_{EXT1} or
30 EF_{CCP1}. If necessary, then the ME performs the reading procedure on these EFs to
31 assemble the complete ADN/SSC.

32 Purge: The ME shall access each EF which references EF_{EXT1} for storage and shall identify
33 records in these files using extension data (additional data or called party
34 subaddress). Note that existing chains have to be followed to the end. All referred
35 Extension1 records are noted by the ME. All Extension1 records not noted are then
36 marked by the ME as "free" by setting the whole record to 'FF'.

1 The following three procedures are only applicable to service n2 (FDN).

2 FDN capability request. The ME shall check the state of service n2, i.e. if FDN is "enabled" or
3 "disabled". If FDN is "enabled", the ME shall only allow outgoing calls. To ascertain the state of FDN,
4 the ME shall check in EF_{CST} and EF_{EST} if FDN is enabled (service "activated" and "available"). In all
5 other cases service n2 is "disabled".

6 FDN enabling is done by activating the FDN service in EF_{EST}.

7 FDN disabling is done by deactivating the FDN service in EF_{EST}.

8 7.3.3 Short Message

9 Requirement: Service n6 "available".

10 Request: The CSIM seeks for the identified short message. If this message is found, the ME
11 performs the reading procedure with EF_{SMS}.

12 If the short message is not found within the CSIM memory, the CSIM indicates that
13 to the ME.

14 Update: The ME looks for the next available area to store the short message. If such an area
15 is available, it performs the updating procedure with EF_{SMS}.

16 If there is no available empty space in the CSIM to store the received short message,
17 a specific MMI will have to take place in order not to lose the message.

18 Erasure: The ME will select in the CSIM the message area to be erased. Depending on the
19 MMI, the message may be read before the area is marked as "free". After performing
20 the updating procedure with EF_{SMS}, the memory allocated to this short message in
21 the CSIM is made available for a new incoming message. The memory of the CSIM
22 may still contain the old message until a new message is stored in this area.

23 If b6 of byte 1 in EF_{SMS} is set to '1' (the message in the corresponding record is
24 protected), then a specific MMI may take place in order not to lose the message.
25

26 7.3.4 Capability configuration parameters

27 Requirement: Service n33 "available".

28 Request: The ME performs the reading procedure with EF_{CCP2}.

29 Update: The ME performs the updating procedure with EF_{CCP2}.

30 Erasure: The ME sends the identification of the requested information to be erased. The
31 content of the identified record in EF_{CCP2} is marked as "free".
32

1 7.3.5 Group Identifier level 1

2 Requirement: Service n23 "available".

3 Request: The ME performs the reading procedure with EF_{GID1}.

5 7.3.6 Group Identifier level 2

6 Requirement: Service n24 "available".

7 Request: The ME performs the reading procedure with EF_{GID2}.

9 7.3.7 Service provider name

10 Requirement: Service n10 "available".

11 Request: The ME performs the reading procedure with EF_{SPN}.

13 7.3.8 Depersonalisation Control Keys

14 Requirement: Service n25 "available".

15 Request: The ME performs the reading procedure with EF_{DCK}.

17 7.3.9 Co-operative Network List

18 Requirement: Service n26 "available".

19 Request: The ME performs the reading procedure with EF_{CDMACNL}.

21 7.3.10 Enabled Services Table Request

22 Requirement: Service n32 "available".

23 Request: The ME performs the reading procedure with EF_{EST}.

24 Update: The ME performs the updating procedure with EF_{EST}.

26 7.3.11 MMS Notifications

27 Requirement: Service n19 "available".

1 Request: The ME sends the identification of the information to be read, and then the ME
 2 performs the reading procedure with EF_{MMSN}. If Service n20 is available the ME
 3 shall analyze the data of EF_{MMSN} to ascertain, whether additional data is associated
 4 in EF_{EXT8}. If necessary, then the ME performs the reading procedure on EF_{EXT8} to
 5 assemble the complete MMS notification.

6 Update: The ME analyzes and assembles the MMS notification to be stored as follows:

- 7 • if the MMS notification contains not more bytes than the maximum possible
 8 number for EF_{MMSN} then the ME looks for the next available area to store the
 9 MMS notification. If such an area is available, it performs the updating
 10 procedure with EF_{MMSN}.
- 11 • if the MMS notification contains more bytes than the maximum possible number
 12 for EF_{MMSN} then the ME seeks for a sufficient number of free records in EF_{EXT8} to
 13 store the complete MMS notification.
 - 14 - If there is not a sufficient number of EF_{EXT8} records marked as "free" to store
 15 the complete MMS notification, the procedure is aborted.
 - 16 - Otherwise, the ME performs the updating procedure and stores as many bytes
 17 as possible in EF_{MMSN}. The Extension file record number of EF_{MMSN} is coded
 18 with the associated record number in the EF_{EXT8}. The remaining bytes are
 19 stored in the selected EF_{EXT8} record where the type of the record is then set to
 20 "additional data". The second byte of the EF_{EXT8} record is set with the number
 21 of bytes of the remaining additional data. It is possible, if the number of
 22 additional digits exceeds the capacity of the additional record, to chain
 23 another record inside the EF_{EXT8} by the identifier in the last byte of the record.
 24 In this case byte 2 of each record for additional data within the same chain
 25 indicates the number of bytes within the same record.

26 The ME is only allowed to store extension data in unused records of EF_{EXT8}

27 If there is no available empty space in the CSIM to store the MMS notification,
 28 it is up to ME implementation how the notification is handled.

29
 30 Erasure: The ME will select in the CSIM the MMS notification to be erased. Depending on the
 31 MMI, the MMS notification may be read before the area is marked as "free". The
 32 memory of the CSIM may still contain the old MMS notification until a new message
 33 is stored. If Service n20 is available all associated records in EF_{EXT8} are then marked
 34 by the ME as "free" by setting them to 'FF'.

36 7.3.12 MMS Issuer Connectivity Parameters

37 Requirement: Service n19 "available".

38 Request: the ME performs the reading procedure with EF_{MMSICP}.

1 Update: The ME performs the updating procedure with EF_{MMSICP}.

2

3 7.3.13 MMS User Preferences

4 Requirement: Service n19 "available".

5 Request: the ME performs the reading procedure with EF_{MMSUP}.

6 Update: The ME performs the updating procedure with EF_{MMSUP}.

7

8 7.3.14 MMS User Connectivity Parameters

9 Requirement: Service n19 and n21 "available".

10 Request: the ME performs the reading procedure with EF_{MMSUCP}.

11 Update: The ME performs the updating procedure with EF_{MMSUCP}.

12 7.3.15 Multimedia Message Storage

13 If the ME supports Multimedia Message Storage on the CSIM, then the following procedures
 14 apply. As defined in [37] a Multimedia Message consists of content, or multimedia objects, and
 15 headers to describe various properties of that content. An MM is stored in EF_{MMDF}, a BER-TLV
 16 structured file.

17 A list of multimedia messages is stored in the BER-TLV file EF_{MML} where each data object identifies
 18 one Multimedia Message stored in EF_{MMDF}.

19 Requirement: Service n30 "available".

20 Request: The ME performs the reading procedures on EF_{MML} to verify the presence and to get
 21 the location information of the targeted MM. Then the ME performs the reading
 22 procedure of the EF_{MMDF} file to get the MM.

23 Update: The ME chooses a free identity (i.e. not listed in EF_{MML}) for the multimedia message
 24 and check for available space in the EF_{MMDF} file. This procedure could be done for
 25 each update or once at the startup of the UE and after a REFRESH command
 26 involving one of the DF_{MULTIMEDIA} files. Then the ME performs the following
 27 procedures:

28 If there is no available empty space in the EF_{MMDF} file to store the MM, the
 29 procedure is aborted and the user is notified.

30 Else, the ME stores the MM in EF_{MMDF}, then updates the information in EF_{MML}
 31 accordingly.

1 Erasure: After a successful deletion of an MM in EF_{MMDf} the ME updates the information in
2 EF_{MML} accordingly.

3

4 **7.4 CCAT Related Procedures**

5 7.4.1 Data Download via SMS-PP

6 Requirement: Service n12 "available".

7 Procedures and commands for Data Download via SMS-PP are defined in [47].

8

9 7.4.2 Data Download via SMS Broadcast

10 Requirement: Service n11 "available".

11 Procedures and commands for Data Download via SMS Broadcast are defined in [47].

12

13

14 7.4.3 Call Control by CSIM

15 Requirement: Service n13 "available".

16 Procedures and commands for Call Control by CSIM are defined in [47].

17

18 7.4.4 Image Request

19 The ME sends the identification of the information to be read. The ME shall analyze the data of
20 EF_{IMG} to identify the files containing the instances of the image. If necessary, then the ME
21 performs READ BINARY commands on these files to assemble the complete image instance data.

8. STRUCTURE OF COMMANDS AND RESPONSES

This section defines the command and response APDU's supported by the UICC.

8.1 Command APDU Structure

See [18] section 10.1

8.1.1 Coding of Class byte

See [18] Section 10.1.1

8.1.2 Coding of Instruction byte

8.1.2.1 Coding of Instruction byte for a telecom application.

See [18] Section 10.1.2

8.1.2.2 Coding of Instruction byte for CSIM

Table 1 depicts coding of additional instruction byte of the commands for CSIM.

Table 1 Coding of additional Instruction Byte of the Commands for a CSIM

COMMAND	CLA	INS
Command APDUs		
Security-related commands		
Manage SSD (Update & Confirm SSD)	8X	'82'
Base Station Challenge	8X	'8A'
Generate Key / VPM	8X	'8E'
Authenticate	0X	'88'
OTASP/OTAPA-related commands		
Generic Key Generation Request	8X	'50'
Commit	8X	'CC'
Validate	8X	'CE'
Generic Configuration Request	8X	'54'
Generic Download Request	8X	'56'
OTAPA Request	8X	'EE'

COMMAND	CLA	INS
Command APDUs		
Secure Mode	8X	'4A'
FRESH	8X	'4C'
ESN Management command		
Store ESN_MEID_ME	8X	'DE'
Packet Data Security-related command		
Compute IP Authentication	8X	'80'
BCMCS-related command		
BCMCS	8X	'58'
Application Authentication command		
Application Authentication	8X	'5A'
AKA-related commands		
UMAC Generation	8X	'5E'
CONFIRM_KEYS	8X	'5C'
LCS-related commands		
S-SAFE Verification & Decryption	8X	'40'
TLS Generate Master Secret	8X	'42'
TLS Generate Verify_data	8X	'44'
TLS Verification and Generate key_block	8X	'46'

1 8.1.3 Coding of Parameter bytes

2 The value of the parameters P1 and P2 depends on the command. If the parameter is not used, the
3 value is set to '00'. Coding of the parameter bytes is presented in Section 8.

4

5 8.1.4 Coding of Lc bytes

6 See [18] Section 10.1.4

7

8 8.1.5 Coding of Data part

9 See [18] Section 10.1.5

1

2 8.1.6 Coding of Le bytes

3 See [18] Section 10.1.6

4

5 **8.2 Response APDU structure**

6 See [18] Section 10.2

7

1 9. COMMANDS

2 9.1 Generic Commands

3 See [18] Section 11.1

4 9.2 CAT Commands

5 See [18] Section 11.2

6 9.3 Data Oriented Commands

7 See [18] Section 11.3

8 9.4 CSIM Commands

9 This section describes the APDU commands, which is only applicable for CSIM. These commands
10 are related to a particular CSIM and shall not be executable unless the CSIM application has been
11 selected and activated, and the current directory is the CSIM ADF or any subdirectory under this
12 ADF and a successful PIN verification procedure has been performed (see Section 7).

13 9.4.1 Security-related Commands

14 The commands *Base Station Challenge*, *Update SSD* and *Confirm SSD* are performed in sequence,
15 as described in [46] Section 4.2 and 4.4.

16 9.4.1.1 Manage SSD

17 9.4.1.1.1 Functional Description

18 Manage SSD consists of *Update SSD* and *Confirm SSD* command (see [46] Section 4.2).

19 They are differentiated by P2 value (see Section 9.4.1.1.2).

20

21 9.4.1.1.2 Command parameters and data

22

Code	Value
CLA	As specified in Section 8.1.1
INS	As specified in Section 8.1.2
P1	'00'
P2	See Table 2
Lc	Length of the subsequent data field
Data	<i>Update SSD</i> or <i>Confirm SSD</i> related data
Le	Not present for both <i>Update SSD</i> and <i>Confirm SSD</i> command

23

Table 2 Coding of P2 of Manage SSD Command

b8	b7	b6	b5	b4	b3	b2	b1	Meaning
0	0	0	0	0	0	0	0	<i>Update SSD</i> command
0	0	0	0	0	0	0	1	<i>Confirm SSD</i> command

a. *Update SSD* command data (P2='00')

The command parameters/data and response parameters/data are coded as [46] Section 4.4.1 (Update SSD).

b. *Confirm SSD* command data (P2='01')

The command parameters/data and response parameters/data are coded as [46] Section 4.4.3 (Confirm SSD).

9.4.1.2 Base Station Challenge

9.4.1.2.1 Functional Description

The function of Base Station Challenge command is described in [46] Section 4.2.1 and 4.4.

9.4.1.2.2 Command parameters and data

The command parameters/data and response parameters/data are coded as [46] Section 4.4.2, where CLA and INS byte shall follow Section 8.1.1, and Le is the length of data expected in response (= '04').

9.4.1.3 Generate Key/VPM

9.4.1.3.1 Functional Description

The function of *Generate Key/VPM* command is described in [46] Section 4.2.2.

This command relies on the prior successful execution of the *Authenticate - Run CAVE* command with the "save" function activated (bit 4 of *Process_Control* parameter). If this has not occurred, the status word SW='98' and SW='34' shall be returned upon the invocation of this command.

9.4.1.3.2 Command parameters and data

The command parameters/data and response parameters/data are coded as [46] Section 4.4.5, where CLA and INS byte shall follow Section 8.1.1, and Le is '00' or maximum the length of data expected in response.

9.4.1.4 Authenticate

9.4.1.4.1 Functional Description

This command performs several authentication functions, i.e.: *Run CAVE*, *3G Authentication AKA*, and *WLAN Authentication AKA*(see [46] Section 4.4.4.)

They are differentiated by P2 value (see Section 9.4.1.4.2).

9.4.1.4.2 Command parameters and data

Code	Value
CLA	As specified in Section 8.1.1
INS	'88'
P1	'00'
P2	See Table 3
Lc	See below
Data	See below
Le	'00', or maximum length of data expected in response

Table 3 Coding of P2 of Authenticate Command

b8	b7	b6	b5	b4	b3	b2	b1	Meaning
1	-	-	-	-	-	-	-	Specific reference data (e.g. DF specific/application dependant key)
1	0	0	0	0	0	0	0	- <i>Run CAVE</i>
1	0	0	0	0	0	0	1	- <i>3G Authentication AKA</i>
1	0	0	0	0	0	1	0	- <i>WLAN Authentication AKA</i>

a. *Run CAVE* command data (P2='80')

The command parameters/data, input parameters and response parameters/data are coded as [46] Section 4.4.4

b. *3G Authentication AKA* command data (P2='81')

The command parameters/data, input parameters and response parameters/data are coded as [46] Section 4.4.4

c. *WLAN Authentication AKA* command data (P2='82')

The command parameters/data, input parameters and response parameters/data are coded as [46] Section 4.4.4

1
2
3
4
5
6
7
8
9
10
11
12
13
14
15
16
17
18
19
20
21
22
23

9.4.2 OTASP/OTAPA-related Commands

This section specifies the CSIM commands which are the mapping of "Request/Response" messages described in [7] and [46] Section 4.3.

9.4.2.1 Generic Key Generation

9.4.2.1.1 Functional Description

This command performs several key generation functions, i.e.: *MS Key Request*, *Key Generation Request*, and *Service Key Generation Request*, which corresponds to *MS Key Request/Response*, *Key Generation Request/Response* and *Service Key Generation Request/Response* messages specified in [7].

Those key generation functions are differentiated by P2 value (see Section 9.4.2.1.2).

As specified in [7], *MS Key Request* function relates to *Key Generation Request* function in a way that *Key Generation Request* follows the *MS Key Request* function.

9.4.2.1.2 Command parameters and data

Code	Value
CLA	As specified in Section 8.1.1
INS	'50'
P1	'00'
P2	See Table 4
Lc	See below
Data	See below
Le	'00', or maximum length of data expected in response

Table 4 Coding of P2 of Generic Key Command

b8	b7	b6	b5	b4	b3	b2	b1	Meaning
0	0	0	0	0	0	0	0	MS Key Request
0	0	0	0	0	0	0	1	Key Generation Request
0	0	0	0	0	0	1	0	Service Key Generation Request

a. *MS Key Request* command data (P2='00')

The command parameters/data, input parameters and response parameters/data are coded as [46] Section 4.5.1

1 b. *Key Generation Request* command data (P2='01')

2 The command parameters/data, input parameters and response parameters/data are coded
3 as [46] Section 4.5.2

5 c. *Service Key Generation Request* command data (P2='02')

6 The command parameters/data, input parameters and response parameters/data are coded
7 as [46] Section 4.5.16

9 9.4.2.2 Commit

10 9.4.2.2.1 Functional Description

11 This command corresponds to *Commit Request/Response* messages specified in [7], Sections
12 4.5.1.6 and 3.5.1.6, respectively.

13 9.4.2.2.2 Command parameters and data

14 The response parameters/data are coded as [46] Section 4.5.3, where CLA and INS byte
15 shall follow Section 8.1.1, Lc is not present, and Le is length of expected data in response (= '01').
16

17 9.4.2.3 Validate

18 9.4.2.3.1 Functional Description

19 This command requests a validation of a single block of data and forms a subset of the
20 *Validation Request Message* as described in [7], Section 4.5.1.10. And the response pertains
21 to a single block of data and forms a subset of the *Validation Response Message* as described
22 in [7], Section 3.5.1.10.

24 9.4.2.3.2 Command parameters and data

25 The command parameters/data and response parameters/data are coded as [46] Section
26 4.5.4, where CLA and INS byte shall follow Section 8.1.1, and Le is length of the data
27 expected in response (= '02').
28

29 9.4.2.4 Generic Configuration Request

30 9.4.2.4.1 Functional Description

31 This command performs several 'configuration request' functions, i.e.: *Configuration Request*,
32 *SSPR Configuration Request*, *PUZL Configuration Request*, *3GPD Configuration Request*, *MMS*
33 *Configuration Request* and *System Tag Configuration Request* which corresponds to
34 *Configuration Request/Response*, *SSPR Configuration Request/Response*, *PUZL Configuration*
35 *Request/Response*, *3GPD Configuration Request/Response* messages, *MMS Configuration*
36 *Request/Response* and *System Tag Configuration Request/Response* specified in [7].

Those 'configuration request' functions are differentiated by P2 value (see Section 9.4.2.4.2).

9.4.2.4.2 Command parameters and data

Code	Value
CLA	As specified in Section 8.1.1
INS	'54'
P1	'00'
P2	See Table 5
Lc	See below
Data	See below
Le	'00', or maximum length of data expected in response

Table 5 Coding of P2 of Generic Configuration Request

b8	b7	b6	b5	b4	B3	b2	b1	Meaning
0	0	0	0	0	0	0	0	Configuration Request
0	0	0	0	0	0	0	1	SSPR Configuration Request
0	0	0	0	0	0	1	0	PUZL Configuration Request
0	0	0	0	0	0	1	1	3GPD Configuration Request
0	0	0	0	0	1	0	0	MMS Configuration Request
0	0	0	0	0	1	0	1	System Tag Configuration Request

a. *Configuration Request* command data (P2='00')

The command parameters/data, input parameters and response parameters/data are coded as [46] Section 4.5.5

b. *SSPR Configuration Request* command data (P2='01')

The command parameters/data, input parameters and response parameters/data are coded as [46] Section 4.5.7

c. *PUZL Configuration Request* command data (P2='02')

The command parameters/data, input parameters and response parameters/data are coded as [46] Section 4.5.10

d. *3GPD Configuration Request* command data (P2='03')

The command parameters/data, input parameters and response parameters/data are coded as [46] Section 4.5.12

1
2
3
4
5
6
7
8
9
10
11
12
13
14
15
16
17
18
19
20
21
22

e. *MMS Configuration Request* command data (P2='04')

The command parameters/data, input parameters and response parameters/data are coded as [46] Section 4.5.19

f. *System Tag Configuration Request* command data (P2='05')

The command parameters/data, input parameters and response parameters/data are coded as [46] Section 4.5.21

9.4.2.5 Generic Download Request

9.4.2.5.1 Functional Description

This command performs several 'download request' functions, i.e.: *Download Request*, *SSPR Download Request*, *PUZL Download Request*, *3GPD Download Request*, *MMS Download Request* and *System Tag Download Request* which corresponds to *Download Request/Response*, *SSPR Download Request/Response*, *PUZL Download Request/Response* and *3GPD Configuration Request/Response* messages, *MMS Configuration Request/ Response* and *System Tag Configuration Request/ Response* specified in [7].

Those 'download request' functions are differentiated by P2 value (see Section 9.4.2.5.2).

9.4.2.5.2 Command parameters and data

Code	Value
CLA	As specified in Section 8.1.1
INS	'56'
P1	'00'
P2	See Table 6
Lc	See below
Data	See below
Le	Maximum length of data expected in response

Table 6 Coding of P2 of Generic Download Request

b8	b7	b6	b5	b4	b3	b2	b1	Meaning
0	0	0	0	0	0	0	0	Download Request
0	0	0	0	0	0	0	1	SSPR Download Request
0	0	0	0	0	0	1	0	PUZL Download Request
0	0	0	0	0	0	1	1	3GPD Download Request
0	0	0	0	0	1	0	0	MMS Download Request
0	0	0	0	0	1	0	1	System Tag Download Request

a. *Download Request* command data (P2='00')

The command parameters/data, input parameters and response parameters/data are coded as [46] Section 4.5.6

b. *SSPR Download Request* command data (P2='01')

The command parameters/data, input parameters and response parameters/data are coded as [46] Section 4.5.8

c. *PUZL Download Request* command data (P2='02')

The command parameters/data, input parameters and response parameters/data are coded as [46] Section 4.5.11

d. *3GPD Download Request* command data (P2='03')

The command parameters/data, input parameters and response parameters/data are coded as [46] Section 4.5.13

e. *MMS Download Request* command data (P2='04')

The command parameters/data, input parameters and response parameters/data are coded as [46] Section 4.5.20

f. *System Tag Download Request* command data (P2='05')

The command parameters/data, input parameters and response parameters/data are coded as [46] Section 4.5.22

9.4.2.6 OTAPA Request

9.4.2.6.1 Functional Description

This command corresponds to *OTAPA Request/Response* messages specified in [7], Sections 4.5.1.11 and 3.5.1.11, respectively.

1 9.4.2.6.2 Command parameters and data

2 The command parameters/data and response parameters/data are coded as mentioned
 3 below, where CLA and INS byte shall follow Section 8.1.1, and Le is the length of the data
 4 expected in response (= '06').

5

Code	Value
CLA	As specified in Section 8.1.1
INS	'EE'
P1	'00'
P2	'00'
Lc	'0C'
Data	See below
Le	'06'

6

7 Command parameters/data:

Octet(s)	Description	Length
1	Start/Stop	1 byte
2 – 5	RANDSeed	4 bytes
6-12	ESN/Pseudo-ESN	7 bytes

8

9 The Start/Stop parameter as defined in Section 4.5.1.11 of [7] shall be coded as follows:

10 Octet 1

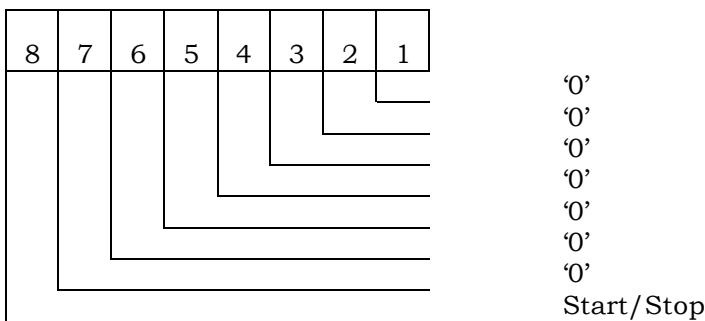

11

12 Response parameters/data:

Octet(s)	Description	Length
1	Result Code	1 byte
2	NAM_LOCK Indicator	1 byte
3 – 6	RAND OTAPA	4 bytes

13

1 The RAND_OTAPA (bytes 3-6) is returned if and only if the Result_Code is '00' and the
 2 NAM_LOCK_STATE is enabled (= '1').

3 The NAM_LOCK Indicator parameter as defined in Section 3.5.1.11 of [7] shall be coded as
 4 follows:

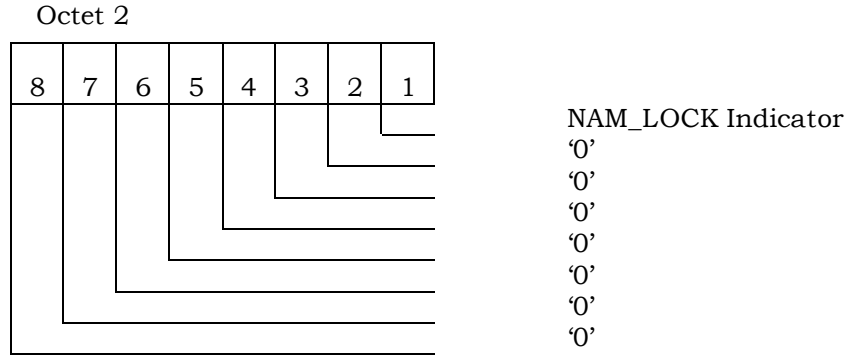

6
 7 Details of the response are in [7], section 3.5.1.11, "OTAPA Response Message".

8
 9 **9.4.2.7 Secure Mode**

10 **9.4.2.7.1 Functional Description**

11 This command corresponds to *Secure Mode Request/Response* messages specified in [7],
 12 Sections 4.5.1.16 and 3.5.1.16, respectively.

13
 14 **9.4.2.7.2 Command parameters and data**

15 The command parameters/data and response parameters/data are coded as [46] Section
 16 4.5.14, where CLA and INS byte shall follow Section 8.1.1, and Le is the length of the data
 17 expected in response (= '01').

18
 19 **9.4.2.8 FRESH**

20 **9.4.2.8.1 Functional Description**

21 The function of *FRESH* command is described in [46] Section 4.3.2.17.

22
 23 **9.4.2.8.2 Command parameters and data**

24 The command parameters/data and response parameters/data are coded as [46] Section
 25 4.5.15, where CLA and INS byte shall follow Section 8.1.1, and Le is either not present or the
 26 length of the data expected in response (= '02') depends on P1 value.

9.4.3 ESN Management Commands

9.4.3.1 Store ESN_MEID_ME

9.4.3.1.1 Functional Description

Code	Value
CLA	As specified in Section 8.1.1
INS	'DE'
P1	See below
P2	'00'
Lc	'08'
Data	See below
Le	'01'

P1 is set to '00' if ME is assigned with ESN;

P1 is set to '01' if ME is assigned with MEID;

9.4.3.1.2 Command parameters/data: (P1 = '00'):

Octet(s)	Description	Length
1	ESN_ME Length	1 byte
2 – 8	ESN_ME	7 bytes

ESN is encoded with the lowest-order byte first to match the coding for EF_{ESNME}.

During the ME and CSIM initialization process, the ME shall invoke the “Store ESN_MEID_ME” command to store its ESN in EF_{ESNME} '6F38'. The ESN_ME length, expressed in octets, is specified by bits 0 through 3, inclusive of Octet 1, where bit 3 is MSB and bit 0 is LSB.

Bits 4 thru 7 of Octet 1 are RFU.

Response parameters/data:

Octet(s)	Description	Length
1	Change Flag, Usage Indicator	1 byte

Bit 0 (LSB) of Octet 1 indicates whether the ESN_ME is different from the previous ESN or MEID that was stored in EF_{ESNME} '6F38'. Bit 0 is set to '0' if the ESN_ME has not changed and is set to '1' if it has changed.

Bits 1 through 3 are RFU are set to '000'.

Bit 4 of Octet 1 form a “Usage Indicator”, as defined in EF 6F42. Bit 4 indicates whether the 32 LSBs of the UIM_ID or the 32 LSBs of the handset ESN are used as the “ESN” input to calculations performed using CAVE. If bit 4 is set to '1', UIM_ID is used for both identification and for authentication calculations; i.e. UIM_ID is used instead of ESN in every place where ESN is used in [5] and [14]. If bit 4 is set to '0', the handset ESN is used for both identification and for authentication calculations.

Bits 5 through 7 of Octet 1 are RFU and are set to '000'.

9.4.3.1.3 Command parameters/data: (P1 = '01'): (assigned with MEID)

Octet(s)	Description	Length
1	MEID Length	1 byte
2 – 8	MEID	7 bytes

During the ME and CSIM initialization process, the ME shall invoke the “Store ESN_MEID_ME” command to store its MEID in EF_{ESNME} '6F38'. The MEID length, expressed in octets, is specified by bits 0 through 3, inclusive, of Octet 1, where bit 3 is MSB and bit 0 is LSB.

Bits 4 through 7 of Octet 1 are RFU.

Response parameters/data:

Octet(s)	Description	Length
1	Change Flag, Usage Indicator	1 byte

Bit 0 (LSB) of Octet 1 indicates whether the MEID is different from the previous ESN or MEID that was stored in EF_{ESNME} '6F38'. Bit 0 is set to '0' if the MEID has not changed and is set to '1' if it has changed.

Bits 1 through 3 are RFU and are set to '000'.

Bit 4 of Octet 1 forms a “Usage Indicator”, as defined in EF_{USGIND} '6F42'. Bit 4 indicates whether the 32 LSBs of the UIM_ID or the 32 LSBs of the handset Pseudo-ESN are used as the “ESN” input to calculations performed using CAVE. If bit 4 is set to '1', UIM_ID is used for both identification and for authentication calculations; i.e. UIM_ID is used instead of pseudo ESN in every place where ESN is used in [5] and [14]. If bit 4 is set to '0', the handset Pseudo-ESN is used for both identification and for authentication calculations.

Bit 5 indicates whether the 56 bits of the SF_EUIMID stored in EF_{SF_EUIMID} or the 56 bits of the handset MEID is used in every place where MEID is used in [5]. If bit 5 is set to '1', then

1 the SF_EUIMID is used. If bit 5 is set to '0', then the handset MEID is used. If service n34 is
2 not available, b5 value shall not be interpreted by the handset.

3 Bits 6 through 7 of Octet 1 are RFU and are set to '00'.
4

5 9.4.4 Packet Data security-related Commands

6 9.4.4.1 Compute IP Authentication

7 9.4.4.1.1 Functional Description

8 This command computes responses and authenticators for use in Simple IP, Mobile IP and
9 HRPD Access Authentication as specified in [46] Section 4.7.
10

11 9.4.4.1.2 Command parameters and data

12 The command parameters/data and response parameters/data are coded as [46] Section
13 4.8.1, where CLA and INS byte shall follow Section 8.1.1, and Le is either not present, '00',
14 or the maximum length of the data expected in response.
15

16 9.4.5 BCMCS-related Commands

17 9.4.5.1 BCMCS

18 9.4.5.1.1 Functional Description

19 This command is used for BCMCS key management as specified in [46] Section 4.9 and 6.
20

21 9.4.5.1.2 Command parameters and data

22 The command parameters/data and response parameters/data are coded as [46] Section
23 4.9, where CLA and INS byte shall follow Section 8.1.1, and Le is either not present or the
24 length of the data expected in response.
25

26 9.4.6 Application Authentication Commands

27 9.4.6.1 Application Authentication

28 9.4.6.1.1 Functional Description

29 The function of *Application Authentication* command is described in [46] Section 4.10.
30

9.4.6.1.2 Command parameters and data

The command parameters/data and response parameters/data are coded as [46] Section 4.10, where CLA and INS byte shall follow Section 8.1.1, and Le is '00' or the maximum length of the data expected in response.

9.4.7 AKA-related Commands

The AKA-related commands are specified in [46] Section 4.11 and 4.12, where the *3G Authentication AKA* function is specified in Section 9.4.1.4.

9.4.7.1 UMAC Generation

9.4.7.1.1 Functional Description

The function of *UMAC Generation* command is described in [46] Section 4.11.

9.4.7.1.2 Command parameters and data

The command parameters/data and response parameters/data are coded as [46] Section 4.12.1, where CLA and INS byte shall follow Section 8.1.1, and Le is '00' or the maximum length of the data expected in response.

9.4.7.2 CONFIRM_KEYS

9.4.7.2.1 Functional Description

The function of CONFIRM_KEYS command is described in [46] Section 4.11.

9.4.7.2.2 Command parameters and data

The command parameters/data and response parameters/data are coded as [46] Section 4.12.2, where CLA and INS byte shall follow Section 8.1.1, and both Lc and Le are not present.

9.4.8 LCS-related Commands

The command/response parameters used in this section refers to [50].

9.4.8.1 S-SAFE Verification Decryption

9.4.8.1.1 Functional Description

This command is used to verify the integrity of 'S-SAFE Envelope' and if necessary to decrypt LCS_S_SAFE_PAYLOAD afterwards. To perform integrity verification and decryption operations, the CSIM calculates a LCS_S_SAFE_KEY, a cipher key and an integrity key. For

1 the execution of the command, the CSIM uses the LCS_ROOT_KEY, which is stored in the
 2 CSIM.

3

4 9.4.8.1.2 Command parameters and data

5

Code	Value
CLA	As specified in Section 8.1.1
INS	'40'
P1	'00'
P2	'00'
Lc	See below
Data	See below
Le	See below

6

7 Command parameters/data:

8

Octet(s)	Description	Length
1 to Lc	S-SAFE Envelope	Lc bytes

9 The S-SAFE Envelope formatting details are in Section 5.2.1 of [50].

10

11 Response parameters/data:

12 The CSIM processes the S-SAFE Envelope as described in Section 5.2.2 of [50].

13 If the value of LCS_S_SAFE_VERSION is not supported then CSIM shall return a status word
 14 SW1='69' and SW2='85' ("Conditions of use not satisfied").

15 If the integrity verification has failed, then the CSIM shall return a status word SW1='98' and
 16 SW2='62' ("Authentication error, incorrect MAC").

17 If the integrity verification succeeds, the CSIM decrypts the LCS_S_SAFE_PAYLOAD. In such
 18 a case, the response parameters/data are:

19

Octet(s)	Description	Length
1 to 2	Length of LCS_S_SAFE_DATA	2 bytes
3 to Le	LCS_S_SAFE_DATA	Le-2 bytes

20

9.4.8.2 TLS Generate Master Secret

9.4.8.2.1 Functional Description

This command is used to generate the *master_secret* as described in Section 5.3.8.1 of [50]. The CSIM will assign a *master_secret_index* for each generated *master_secret*. CSIM shall securely store the *master_secret* and its corresponding *master_secret_index*, and shall only return the *master_secret_index* to the ME.

In order to generate the *master_secret*, CSIM first calculates the LCS_UIM_HPS_TLS_PSK_KEY for TLS Session-A; or LCS_UIM_PDE_ROOT_KEY and LCS_UIM_PDE_TLS_PSK_KEY for TLS Session-B. For the execution of the command, the CSIM uses the LCS_ROOT_KEY, which is stored in the CSIM.

9.4.8.2.2 Command parameters and data

Code	Value
CLA	As specified in Section 8.1.1
INS	'42'
P1	'00'
P2	(See Detail 1)
Lc	See below
Data	See below
Le	See below

Detail 1:

If DHE Key exchange is used, then the resulting *other_secrets* parameter (equal to the shared secret DH key) inside the data field parameter is so large that it is possible to have Lc exceeds 254 bytes. Therefore, this command shall chain successive blocks of with a maximum size of 254 bytes each. If the blocks used within the command are run out of sequence, the card shall return, SW1='98' and SW2='34'.

P2 contains chaining information as follows:

b8	b7	b6	b5	b4	b3	b2	b1	Meaning
0	0	0	0	0	0	0	0	First block
X	X	X	X	0	0	0	1	'xxxx' indicates (n+1) th next block. '0000 0001' = 1 st next block. '0001 0001' = 2 nd next block. '0010 0001' = 3 rd next block. ... '1111 0001' = 16 th next block.
0	0	0	0	0	0	1	0	Single block
0	0	0	0	0	0	1	1	Last block

1 * Le: 'Not present' for P2 = '00' or 'x1'
 2 16 bytes for P2 = '02' or '03'

3
 4 Command parameters/data:

5 a. Operation for TLS Session-A (SessionType='01')

Octet(s)	Description	Length
1	TLS Service Type (see Table 7)	1 byte
2	SessionType	1 byte
3 to A+2	TLS Server_Version TLV	A bytes
A+3 to A+B+2	TLS Other_Secret TLV	B bytes
A+B+3 to A+B+C+2	TLS Master_Client_Random TLV	C bytes
A+B+C+3 to A+B+C+D+2	TLS Master_Server_Random TLV	D bytes
NOTE: The tags inside TLV objects in the command are specified in Annex D of this document.		

7
 8 The coding for 'TLS Service Type' is defined according to the following table:

9 **Table 7 Coding of 'TLS Service Type'**

Binary Value	Service Type
'00000000'	IP-based Location Services
Others	Reserved

10 For "IP-based Location Services" (i.e. 'TLS Service Type' = '0x00'), see [50] for the definition of
 11 the remaining input parameters.

1 *b. Operation for TLS Session-B (SessionType='02')*

2

Octet(s)	Description	Length
1	TLS Service Type (Table 7)	1 byte
2	SessionType	1 byte
2 to A+2	TLS PSK VERSION TLV	A bytes
A+3 to A+B+2	TLS PSK EXPIRY TLV	B bytes
A+B+3 to A+B+C+2	TLS PSK RAND TLV	C bytes
A+B+C+3 to A+B+C+D+2	TLS PSK EXTRAS TLV	D bytes
A+B+C+D+3 to A+B+C+D+2	TLS Server_Version TLV	E bytes
A+B+C+D+E+3 to A+B+C+D+E+F+2	TLS Other_Secret TLV	F bytes
A+B+C+D+E+F+3 to A+B+C+D+E+F+G+2	TLS Master_Client_Random TLV	G bytes
A+B+C+D+E+F+G+3 to A+B+C+D+E+F+G+H+2	TLS Master_Server_Random TLV	H bytes
NOTE: The tags inside TLV objects in the command are specified in Annex D of this document.		

3
4
5 Response parameters/data:

6

Octet(s)	Description	Length
1 to 2	<i>master_secret_index</i>	2 bytes

7
8 9.4.8.3 TLS Generate Verify Data

9 9.4.8.3.1 Functional Description

10 This command is used to generate both TLS Session-A and TLS Session-B client's
11 *verify_data*, as described in [50].

9.4.8.3.2 Command parameters and data

Code	Value
CLA	As specified in Section 8.1.1
INS	'44'
P1	'00'
P2	'00'
Lc	See below
Data	See below
Le	See below

Command parameters/data:

Octet(s)	Description	Length
1	TLS Service Type (see Table 7)	1 byte
2 to 3	TLS Master_Secret_Index TLV	2 bytes
4 to A+3	TLS MS Verify_Digest TLV	A bytes
NOTE: The tags inside TLV objects in the command are specified in Annex D of this document.		

Response parameters/data:

Octet(s)	Description	Length
1-2	MS Verify Data Length	2 bytes
3 to B+2	MS Verify Data	B bytes

9.4.8.4 9.4.8.4 TLS Verify Data & Generate Key Block

9.4.8.4.1 Functional Description

This command is used to verify the Server's *verify_data* from the server (HPS or PDE) during TLS Session-A or TLS Session-B handshake, and then generates the *key_block* data, as described in [50].

9.4.8.4.2 Command parameters and data

Code	Value
CLA	As specified in Section 8.1.1
INS	'46'
P1	'00'
P2	'00'
Lc	See below
Data	See below
Le	See below

Command parameters/data:

Octet(s)	Description	Length
1	TLS Service Type (see Table 7)	1 byte
2 to A+1	TLS Server_Version TLV	A bytes
A+2 to A+B+1	TLS Master_Secret_Index TLV	B bytes
A+B+2 to A+B+C+1	TLS Current_Client_Random TLV	C bytes
A+B+C+2 to A+B+C+D+1	TLS Current_Server_Random TLV	D bytes
A+B+C+D+2 to A+B+C+D+E+1	TLS Server_Verify_Digest TLV	E bytes
A+B+C+D+E+2 to A+B+C+D+E+F+1	TLS Server_Verify_Data TLV	F bytes
A+B+C+D+E+F+2 to A+B+C+D+E+F+3	TLS Key_Block_Len	2 bytes
NOTE: The tags inside TLV objects in the command are specified in Annex D of this document.		

Response parameters/data:

Octet(s)	Description	Length
1-2	TLS <i>key_block</i> Length	2 bytes
3 to G+2	TLS <i>key_block</i>	G bytes

If the verification fails, the CSIM shall return a status word SW1='98' and SW2='62' ("Authentication error")

1 **10. DESCRIPTION OF SERVICES-RELATED PROCEDURE**

2 **10.1 IP-based Location Services Procedures [50]**

3 10.1.1 Functionalities of CSIM and ME

4 10.1.1.1 CSIM

- 5 - Generate LCS_UIM_S_SAFE Key, LCS_UIM_HPS_TLS_PSK Key and LCS_UIM_PDE_ROOT
- 6 Key from LCS Root Key. This may be done at the same time when LCS Root Key is
- 7 provisioned or may be later.

- 8 - Generate LCS_S_SAFE_CK and LCS_S_SAFE_IK from LCS_UIM_S_SAFE Key after receiving
- 9 the 'S-SAFE Verification and Decryption' command from ME, and

- 10 - perform Integrity Verification to LCS_S_SAFE_MAC_DATA with LCS_S_SAFE_IK, and

- 11 - when necessary, decrypt LCS_S_SAFE_PAYLOAD with LCS_S_SAFE_CK.

- 12 - Compute *master_secret* with input parameters after receiving the 'TLS Generate Master
- 13 Secret' command from ME, assign a unique 16-bit *master_secret_index* for the calculated
- 14 *master_secret*.

- 15 - Compute Session-A (or Session-B) *verify_data* with input parameters after receiving the 'TLS
- 16 Generate *verify_data*' command from ME.

- 17 - Verify the received H-PS (or PDE) Verify Data and if success then generate a *key_block* from
- 18 inputs parameters after receiving the 'TLS Verify data and Generate *key_block*' command
- 19 from ME.

20 10.1.1.2 ME

- 21 - Perform Expiry Check and Replay Detection against S-SAFE envelop

- 22 - Generate MS Verify Digest.

- 23 - Generate MS *session_secret*.

- 24 - Perform bulk ciphering and integrity check for TLS Session-A application data with Session-
- 25 A Session Secret

- 26 - Perform bulk ciphering and integrity check for TLS Session-B application data with Session-
- 27 B Session Secret

- 28 - Issue correct command with appropriate parameters to CSIM.

30 10.1.2 Key Management

31 If service n17 is available, these following keys shall be securely maintained in the CSIM:

- 32 - LCS_ROOT_KEY.

- 1 - three PSK keys (i.e. LCS_UIM_S_SAFE Key, LCS_UIM_HPS_TLS_PSK Key and
2 LCS_UIM_PDE_ROOT Key) derived from LCS_ROOT_KEY.
- 3 - *master_secret* and *master_secret_index*

4

5 When ME sends a 'TLS Generate Master Secret' command for TLS Session-B, the CSIM shall
6 generate a LCS_UIM_PDE_TLS_PSK_KEY from LCS_UIM_PDE_ROOT_KEY and the input
7 parameter LCS_UIM_PDE_TLS_PSK_RAND. LCS_UIM_PDE_TLS_PSK_KEY (not the
8 LCS_UIM_PDE_ROOT Key) shall then be used to generate the requested *master_secret*.

1 **ANNEX A (INFORMATIVE) R-UIM/CSIM FILE MAPPING TABLE**

2 The following section provides some guidelines for file mapping between an R-UIM and CSIM in a
3 UICC. It should be noted that some files are optional, and these files are not necessarily present in
4 the R-UIM or CSIM application. Mapping with multiple CSIM's is not considered.

5

- 6 1. Files mapped between an R-UIM and a CSIM should be of the same size.
- 7 2. If subscription related information is different across an R-UIM and a CSIM, the files cannot
8 be mapped.
- 9 3. Mapping is not possible if the file is applicable only either to an R-UIM or a CSIM,
10 e.g. EF_{Revision}.
- 11 4. Case by case analysis has to be done by the network operators/card manufacturers for files to
12 be mapped that are specific to the terminal, e.g. ESN, MEID files, etc that contains device
13 specific information.

1 **ANNEX B (NORMATIVE)**

2 List of SFI Values

3

File Identification	SFI	Description
'6F43'	'01'	Administrative data
'6F32'	'02'	CSIM Service Table
'6F2C'	'03'	Access Overload Class
'6F22'	'04'	IMSI_M
'6F23'	'05'	IMSI_T
'6F24'	'06'	TMSI
'6F30'	'07'	PRL
'6F41'	'08'	Home Service Provider Display Information
'6F47'	'09'	Emergency Call Codes
'6F3A'	'0A'	Language Indication
'6F6B'	'0B'	3G Cipher and Integrity Key
'6F28'	'0C'	CDMA Home SID and NID
'6F2A'	'0D'	CDMA System-Network Registration Indicators
'6F5A'	'0E'	Extended PRL
'6F75'	'0F'	Enabled Services Table
'6F7C'	'10'	Incoming Call Information
'6F7D'	'11'	Outgoing Call Information
'6F7F'	'12'	Capability Control Parameters2

1 **ANNEX C (INFORMATIVE)**

2 CSIM Application Session Activation/Termination

3 The purpose of this annex is to illustrate the different Application Session procedures.

4

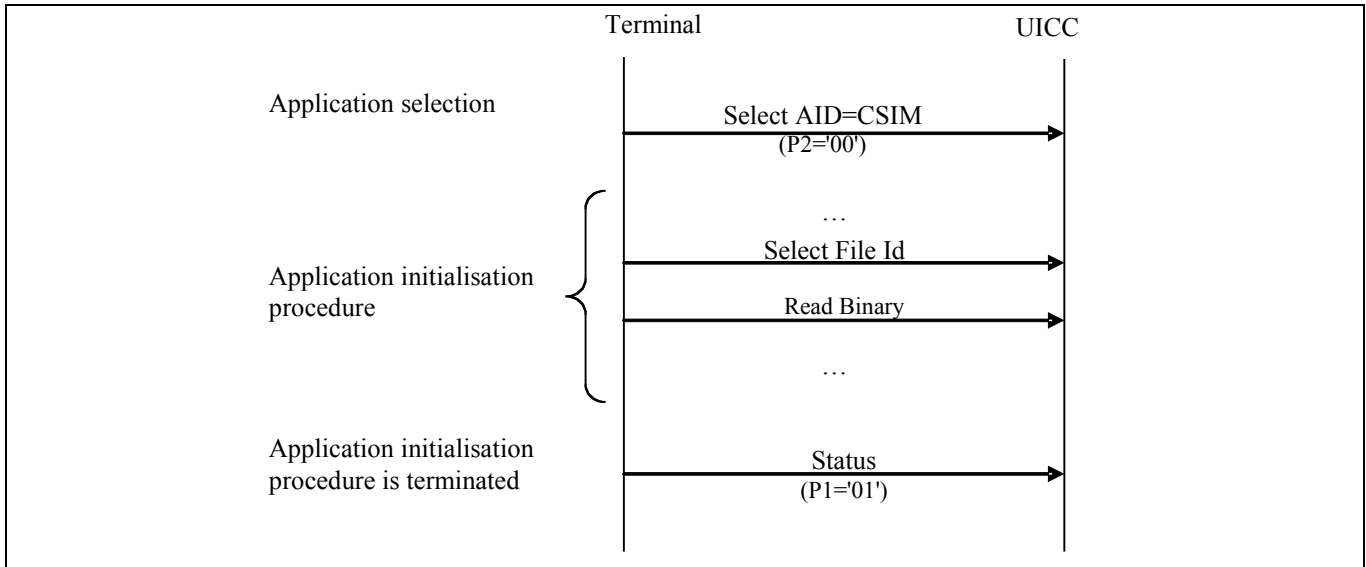

5

6 **Figure 1 CSIM Application Session Activation Procedures**

7

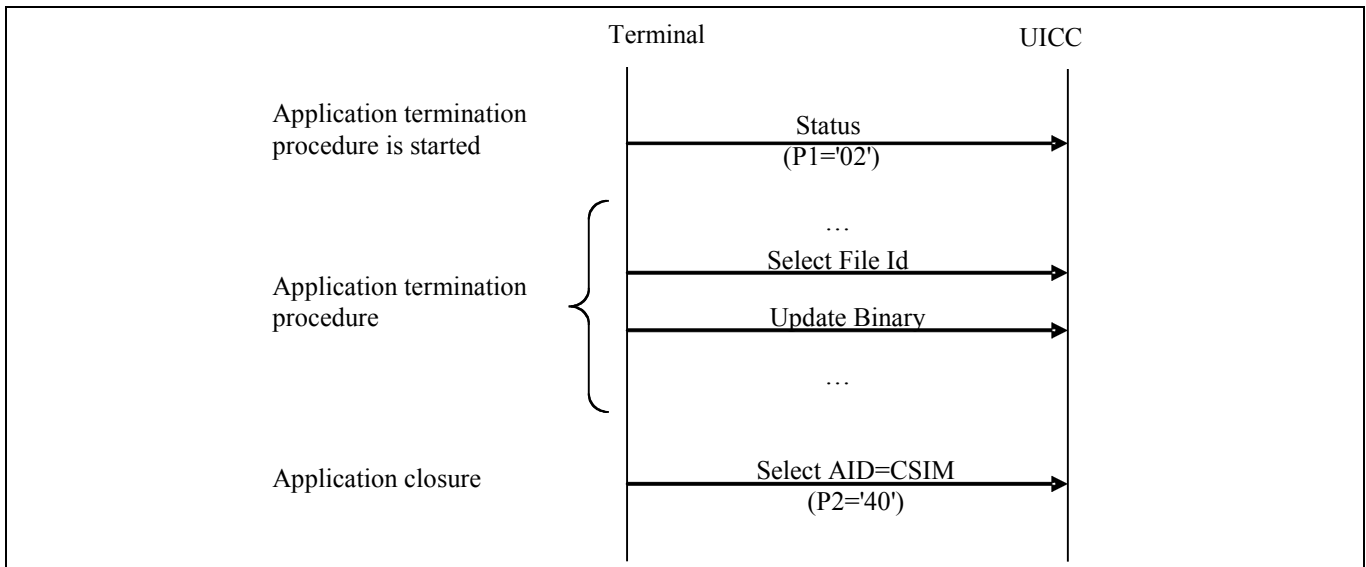

8

9 **Figure 2 CSIM Application Session Termination Procedures**

10

1 **ANNEX D (NORMATIVE): TLS-RELATED TAG VALUES**

2

Tag	Name of Data Element	Usage
'80'	TLS Server_Version TLV objects	TLS command
'81'	TLS Cipher_Suite TLV objects	TLS command
'82'	TLS Other_Secret TLV object	TLS command
'83'	TLS Master_Client_Random TLV object	TLS command
'84'	TLS Master_Server_Random TLV object	TLS command
'85'	TLS Current_Client_Random TLV object	TLS command
'86'	TLS Current_Server_Random TLV object	TLS command
'87'	TLS Server Verify_Digest TLV object	TLS command
'88'	TLS Server Verify_Data TLV object	TLS command
'89'	TLS MS Verify_Digest TLV object	TLS command
'8A'	TLS_Master_Secret_Index TLV object	TLS command
'8B'	TLS PSK VERSION TLV	TLS command
'8C'	TLS PSK EXPIRY TLV	TLS command
'8D'	TLS PSK RAND TLV	TLS command
'8E'	TLS PSK EXTRAS TLV	TLS command

3

1 **ANNEX D (NORMATIVE): TLS-RELATED TAG VALUES**

2

Tag	Name of Data Element	Usage
'80'	TLS Server_Version TLV objects	TLS command
'81'	TLS Cipher_Suite TLV objects	TLS command
'82'	TLS Other_Secret TLV object	TLS command
'83'	TLS Master_Client_Random TLV object	TLS command
'84'	TLS Master_Server_Random TLV object	TLS command
'85'	TLS Current_Client_Random TLV object	TLS command
'86'	TLS Current_Server_Random TLV object	TLS command
'87'	TLS Server Verify_Digest TLV object	TLS command
'88'	TLS Server Verify_Data TLV object	TLS command
'89'	TLS MS Verify_Digest TLV object	TLS command
'8A'	TLS_Master_Secret_Index TLV object	TLS command
'8B'	TLS PSK VERSION TLV	TLS command
'8C'	TLS PSK EXPIRY TLV	TLS command
'8D'	TLS PSK RAND TLV	TLS command
'8E'	TLS PSK EXTRAS TLV	TLS command

3

ANNEX E (INFORMATIVE): SUGGESTED CONTENTS OF THE EFS AT PRE-PERSONALIZATION

Table 8 is a general outline of the CSIM files defined in this specification.

1. All values are sized in bytes unless otherwise noted.
2. Default Values are specified when available and are intended to be guidelines only. In some cases, operators must specify explicit parameter values as no logical default exists. In the case where the parameter values are necessary, valid values and/or ranges are listed.
3. Default and Parameter values are for general quick reference only and not intended to specify details. Refer to the corresponding file for details.
4. Default Values and Parameter Values are specified in Hexadecimal, unless otherwise noted.
5. GSM-specific files are not included.
6. If EFs have an unassigned value, it may not be clear from the main text what this value should be. This annex suggests values in these cases.

Table 8 Summary of CSIM Files

File Name	File ID	File Type	Access - Read	Access - Update	Access – Invalidate-Rehabilitate	Size in Bytes	Mandatory or Optional	Default Values (D) and/or Parameter Values (P) in Bytes
Authentication – NAM Parameters and Operational Parameters								
A-Key	-	-	Never	Never	-	8	M	Specified by Operator
Root Key	-	-	Never	Never	-	16	M	Specified by Operator
BCMCS Root Key	-	-	Never	Never	-	16	O	Specified by Operator
IMS Root Key	-	-	Never	Never	-	16	O	Specified by Operator
WLAN Root Key	-	-	Never	Never	-	16	O	Specified by Operator

File Name	File ID	File Type	Access - Read	Access - Update	Access – Invalidate-Rehabilitate	Size in Bytes	Mandatory or Optional	Default Values (D) and/or Parameter Values (P) in Bytes
SSD	-	-	Never	Never	-	16	M	-
EF _{COUNT}	6F21	CY	PIN	PIN	ADM-ADM	2	M	D = '00 00'
BAK	-	-	Never	Never	-	16	O	Specified by Operator
UpdatedBAK	-	-	Never	Never	-	16	O	Specified by Operator
SharedSecret	-	-	Never	Never	-	Variable	O	Specified by Operator
UAK	-	-	Never	Never	-	16	O	Specified by Operator
SQN _{MS}	-	-	Never	Never	-	6	O	-
NAM Parameters and Operational Parameters								
EF _{IMSI_M}	6F22	TR	PIN	ADM	ADM-PIN	10	M	P = Specified by Operator or D='00...00'
EF _{IMSI_T}	6F23	TR	PIN	ADM	ADM-PIN	10	M	P = Specified by Operator or D='00...00'
EF _{TMSI}	6F24	TR	PIN	PIN	ADM-PIN	16	M	D = '00 00 00 00 00 00 00 00 00 00 FF FF FF FF 00 00 00'
EF _{AH}	6F25	TR	PIN	PIN	ADM-ADM	2	M	P = Specified by Operator or D = '00 00'
EF _{AOP}	6F26	TR	PIN	PIN	ADM-ADM	1	M	-
EF _{ALOC}	6F27	TR	PIN	PIN	ADM-ADM	7	M	-
EF _{CDMAHOME}	6F28	LF	PIN	PIN	ADM-ADM	5	M	P = Specified by Operator or D = '00 00 00 00 00'
EF _{ZNREGI}	6F29	LF	PIN	PIN	ADM-ADM	8	M	D = '00 00 00 00 00 00 00 00'
EF _{SNREGI}	6F2A	TR	PIN	PIN	ADM-ADM	7	M	-
EF _{DISTREGI}	6F2B	TR	PIN	PIN	ADM-ADM	8	M	D = '00 00 00 00 00 00 00 00'
EF _{ACCOLC}	6F2C	TR	PIN	ADM	ADM-ADM	1	M	P = '00' to '0F' derived from IMSI_M /

File Name	File ID	File Type	Access - Read	Access - Update	Access – Invalidate-Rehabilitate	Size in Bytes	Mandatory or Optional	Default Values (D) and/or Parameter Values (P) in Bytes
								IMSI_T
EF _{TERM}	6F2D	TR	PIN	PIN	ADM-ADM	1	M	Specified by Operator P = '00' to '07'
EF _{SSCI}	6F2E	TR	PIN	PIN	ADM-ADM	1	O	Specified by Operator P = '00' to '07'
EF _{ACP}	6F2F	TR	PIN	PIN	ADM-ADM	7	M	Specified by Operator
EF _{PRL}	6F30	TR	PIN	ADM	ADM-ADM	Variable	M	Specified by Operator
EF _{RUIMID}	6F31	TR	ALW	NEVER	NEVER-NEVER	8	M	Specified by CSIM Manufacturer
EF _{CST}	6F32	TR	PIN	ADM	ADM-ADM	Variable	M	Specified by Operator
EF _{SPC}	6F33	TR	ADM	ADM	ADM-ADM	3	M	D = '00 00 00' or P = '00 00 00' to '99 99 99'
EF _{OTAPASPC}	6F34	TR	PIN	PIN	ADM-ADM	1	M	Specified by Operator or D = '00'
EF _{NAMLOCK}	6F35	TR	PIN	PIN	ADM-ADM	1	M	Specified by Operator
EF _{OTA}	6F36	TR	PIN	ADM	ADM-ADM	Variable	M	P = Defined in [7]
EF _{SP}	6F37	TR	PIN	PIN	ADM-ADM	1	M	Specified by Operator
EF _{ESNME}	6F38	TR	ALW	ADM	ADM-ADM	8	M	D = '00...00'
EF _{PL}	6F3A	TR	ALW	PIN	ADM-ADM	Variable	M	D = 'FF... FF'
EF _{SMS}	6F3C	LF	PIN	PIN	ADM-ADM	Variable	O	D = '00 FF...FF'
EF _{SMSp}	6F3D	LF	PIN	PIN	ADM-ADM	Variable	O	D = 'FF...FF'
EF _{SMSS}	6F3E	TR	PIN	PIN	ADM-ADM	Variable	O	D = 'FF...FF'
EF _{SSFC}	6F3F	TR	PIN	PIN	ADM-ADM	Variable	O	Specified by Operator

File Name	File ID	File Type	Access - Read	Access - Update	Access – Invalidate-Rehabilitate	Size in Bytes	Mandatory or Optional	Default Values (D) and/or Parameter Values (P) in Bytes
EF _{SPN}	6F41	TR	ALW	ADM	ADM-ADM	35	O	Specified by Operator
EF _{USGIND}	6F42	TR	PIN	ADM	ADM-ADM	1	M	Specified by Operator
EF _{AD}	6F43	TR	ALW	ADM	ADM-ADM	Variable	M	D = '00...00'
EF _{MDN}	6F44	LF	PIN	PIN	ADM-ADM	11	O	Specified by Operator
EF _{MAXPRL}	6F45	TR	PIN	ADM	ADM-ADM	2 or 4	M	Specified by Operator
EF _{SPCS}	6F46	TR	PIN	NEVER	NEVER-NEVER	1	M	P = If EF 6F33 is set to default value then D = '00' otherwise D = '01'
EF _{ECC}	6F47	TR	ALW	ADM	ADM-ADM	Variable	O	D = 'FF'
EF _{ME3GPDOPC}	6F48	TR	PIN	PIN	ADM-ADM	1	O	D = '00'
EF _{3GPDOPM}	6F49	TR	PIN	ADM	ADM-ADM	1	O	Specified by Operator
EF _{SIPCAP}	6F4A	TR	PIN	ADM	ADM-ADM	4	O	Specified by Operator
EF _{MIPCAP}	6F4B	TR	PIN	ADM	ADM-ADM	5	O	Specified by Operator
EF _{SIPUPP}	6F4C	TR	PIN	ADM	ADM-ADM	Variable	O	Specified by Operator
EF _{MIPUPP}	6F4D	TR	PIN	ADM	ADM-ADM	Variable	O	Specified by Operator
EF _{SIPSP}	6F4E	TR	PIN	PIN	ADM-ADM	1	O	Specified by Operator
EF _{MIPSP}	6F4F	TR	PIN	PIN	ADM-ADM	Variable	O	Specified by Operator
EF _{SIPPAPSS}	6F50	TR	PIN	PIN	ADM-ADM	Variable	O	Specified by Operator
SimpleIP CHAP SS	-	-	Never	Never	-	Variable	O	Specified by Operator
MobileIP SS	-	-	Never	Never	-	Variable	O	Specified by Operator
Shared Secret	-	-	Never	Never	-	Variable	O	Specified by Operator

File Name	File ID	File Type	Access - Read	Access - Update	Access – Invalidate-Rehabilitate	Size in Bytes	Mandatory or Optional	Default Values (D) and/or Parameter Values (P) in Bytes
EF _{PUZL}	6F53	TR	PIN	ADM	ADM-ADM	Variable	O	Specified by Operator
EF _{MAXPUZL}	6F54	TR	PIN	ADM	ADM-ADM	5	O	Specified by Operator
EF _{MECRP}	6F55	TR	PIN	PIN	ADM-ADM	3	M	D = '00 00 00'
EF _{HRPD CAP}	6F56	TR	PIN	ADM	ADM-ADM	2	O	Specified by Operator
EF _{HRPDUPP}	6F57	TR	PIN	ADM	ADM-ADM	Variable	O	Specified by Operator
HRPD AA CHAP SS	-	-	Never	Never	-	Variable	O	Specified by Operator
EF _{CSSPR}	6F58	TR	PIN	ADM	ADM-ADM	1	O	D = 'FF'
EF _{ATC}	6F59	TR	PIN	ADM	ADM-ADM	1	O	Specified by Operator
EF _{EPRL}	6F5A	TR	PIN	ADM	ADM-ADM	Variable	O	Specified by Operator
EF _{BCSMScfg}	6F5B	TR	PIN	ADM	ADM-ADM	1	O	Specified by Operator
EF _{BCSMSpref}	6F5C	TR	PIN	PIN	ADM-ADM	1	O	D = 'FF'
EF _{BCSMStable}	6F5D	LF	PIN	ADM	ADM-ADM	Variable	O	D = '00 FF...FF'
EF _{BCSMSp}	6F5E	LF	PIN	PIN	ADM-ADM	2	O	D = 'FF FF'
EF _{BAKPARA}	6F63	LF	PIN	ADM	ADM-ADM	Variable	O	Specified by Operator
EF _{UpBAKPARA}	6F64	CY	PIN	ADM	ADM-ADM	Variable	O	Specified by Operator
EF _{MMSN}	6F65	LF	PIN	PIN	ADM-ADM	Variable	O	D='00 00 00 FF...FF'
EF _{EXT8}	6F66	LF	PIN	PIN	ADM-ADM	Variable	O	D='FF...FF'
EF _{MMSICP}	6F67	TR	PIN	ADM	ADM-ADM	Variable	O	D='FF...FF'
EF _{MMSUP}	6F68	LF	PIN	PIN	ADM-ADM	Variable	O	D='FF...FF'
EF _{MMSUCP}	6F69	TR	PIN	PIN/PIN2	ADM-ADM	Variable	O	D= 'FF...FF'

File Name	File ID	File Type	Access - Read	Access - Update	Access – Invalidate-Rehabilitate	Size in Bytes	Mandatory or Optional	Default Values (D) and/or Parameter Values (P) in Bytes
EF _{AuthCapability}	6F6A	LF	PIN	ADM	ADM-ADM	Variable	O	D= '00...00'
EF _{3GCIK}	6F6B	TR	PIN	ADM	ADM-ADM	32	O	Specified by Operator
EF _{DCK}	6F6C	TR	PIN	PIN	ADM-ADM	20	O	Specified by Operator
EF _{GID1}	6F6D	TR	PIN	ADM	ADM-ADM	N	O	Specified by Operator
EF _{GID2}	6F6E	TR	PIN	ADM	ADM-ADM	N	O	Specified by Operator
EF _{CDMACNL}	6F6F	TR	PIN	ADM	ADM-ADM	7N	O	Specified by Operator
EF _{HOME_TAG}	6F70	TR	PIN	ADM	ADM-ADM	N	O	Specified by Operator
EF _{GROUP_TAG}	6F71	TR	PIN	ADM	ADM-ADM	Variable	O	Specified by Operator
EF _{SPECIFIC_TAG}	6F72	TR	PIN	ADM	ADM-ADM	Variable	O	Specified by Operator
EF _{CALL_PROMPT}	6F73	TR	PIN	ADM	ADM-ADM	Variable	O	Specified by Operator
EF _{SF_EUIMID}	6F74	TR	ALW	NEVER	NEVER-NEVER	7	O	Specified by CSIM Manufacturer
EF _{EST}	6F75	TR	PIN	PIN	ADM-ADM	Variable	O	Specified by Operator
EF _{HIDDEN_KEY}	6F76	TR	PIN	ADM	ADM-ADM		O	Specified by Operator
EF _{LCSVER}	6F77	TR	PIN	ADM	ADM-ADM	Variable	O	Specified by Operator
EF _{LCSCP}	6F78	TR	PIN	ADM	ADM-ADM	Variable	O	Specified by Operator
EF _{SDN}	6F79	LF	PIN	PIN2	ADM-ADM	Variable	O	Specified by Operator
EF _{EXT2}	6F7A	LF	PIN	ADM	ADM-ADM	13	O	Specified by Operator
EF _{EXT3}	6F7B	LF	PIN	PIN	ADM-ADM	13	O	Specified by Operator
EF _{ICI}	6F7C	CY	PIN	PIN	ADM-ADM	Variable	O	Specified by Operator
EF _{Oci}	6F7D	CY	PIN	PIN	ADM-ADM	Variable	O	Specified by Operator

File Name	File ID	File Type	Access - Read	Access - Update	Access – Invalidate-Rehabilitate	Size in Bytes	Mandatory or Optional	Default Values (D) and/or Parameter Values (P) in Bytes
EF _{EXT5}	6F7E	LF	PIN	PIN	ADM-ADM	13	O	Specified by Operator
EF _{CCP2}	6F7F	LF	PIN	PIN	ADM-ADM	Variable	O	Specified by Operator
EF _{AppLabels}	6F80	TR	PIN	ADM	ADM-ADM	Variable	O	Specified by Operator
EF _{Model}	6F81	TR	PIN	PIN	ADM-ADM	126	O	D='FF...FF'
EF _{RC}	6F82	TR	ALW	ADM	ADM-ADM	Variable	O	Specified by Operator
EF _{SMSCAP}	6F83	TR	PIN	ADM	ADM-ADM	4	O	Specified by Operator
EF _{MIPFlags}	6F84	TR	PIN	ADM	ADM-ADM	1	O	Specified by Operator
EF _{SIPUPPEExt}	6F85	TR	PIN	ADM	ADM-ADM	Variable	O	Specified by Operator
EF _{MIPUPPEExt}	6F86	TR	PIN	ADM	ADM-ADM	Variable	O	Specified by Operator
EF _{IPV6CAP}	6F87	TR	PIN	ADM	ADM-ADM	21	O	Specified by Operator
EF _{TCPConfig}	6F88	TR	PIN	ADM	ADM-ADM	2	O	Specified by Operator
EF _{DGC}	6F89	TR	PIN	ADM	ADM-ADM	3	O	Specified by Operator
EF _{WAPBrowserCP}	6F8A	TR	PIN	ADM	ADM-ADM	Variable	O	Specified by Operator
EF _{WAPBrowserBM}	6F8B	TR	PIN	PIN	ADM-ADM	Variable	O	D='FF...FF'
EF _{MMSConfig}	6F8C	TR	PIN	ADM	ADM-ADM	8	O	Specified by Operator
EF _{JDL}	6F8D	TR	PIN	ADM	ADM-ADM	Variable	O	Specified by Operator

1 **ANNEX F (NORMATIVE): RESERVATION OF FILE IDENTIFIERS**

2 The following FIDs are reserved by the present document:

- 3 • ADF:
 - 4 ○ Operational use (implicit FID for the current ADF):
 - 5 ▪ '7FFF'.
- 6 • Dedicated Files:
 - 7 ○ Administrative use:
 - 8 ▪ '7F4X', '5F1X', '5F2X'.
 - 9 ○ Operational use:
 - 10 ▪ '7F10' (DFTELECOM), '7F20' (DFGSM), '7F21' (DFDCS1800), '7F22' (DFIS-41), '7F23' (DFFP-CTS),
 - 11 ▪ '7F24' (DFTIA/EIA-136), '7F25' (DFTIA/EIA-95) and '7F2X', where X ranges from '6' to 'F'.

12 NOTE: '7F80' (DFPDC) is used for the Japanese PDC specification.

13 '7F90' (DFTETRA) is used for the TETRA specification.

14 '7F31' (DFIDEN) is used in the iDEN specification.

- 15 ○ Reserved under '7F10':
 - 16 ▪ '5F50' (DFGRAPHICS); '5F3A' (DFPHONEBOOK).
- 17 • Elementary files:
 - 18 ○ Administrative use:
 - 19 ▪ '6F XX' in the DFs '7F 4X'; '4F XX' in the DFs '5F 1X', '5F2X'.
 - 20 ▪ '6F 1X' in the DFs '7F 10', '7F 20', '7F 21';
 - 21 ▪ '4F 1X' in all 2nd level DFs;
 - 22 ▪ '2F EX' in the MF '3F 00'.

C.S0065-A v1.0

- 1 ○ Operational use:
- 2 ▪ '6F 2X', '6F 3X', '6F 4X' in '7F 10' and '7F 2X';
- 3 ▪ '4F YX', where Y ranges from '2' to 'F' in all 2nd level DFs;
- 4 ▪ '2F05', '2F06' and '2F 1X' in the MF '3F 00'.
- 5 ○ Operational use ISO/IEC 7816-4 [12]:
- 6 ▪ '2F00' EFDIR, '2F01' EFATR in the MF '3F00'.
- 7 ○ Reserved under CDMA ADF:
- 8 ▪ From '6F8E' to '6F96' (reserved for CDG)

9

10 In all the above, X ranges, unless otherwise stated, from '0' to 'F'.